

SBML Level 3 Package Specification

Multistate, Multicomponent and Multicompartment Species Package for SBML Level 3

Fengkai Zhang
zhangfen@niaid.nih.gov
Laboratory of Systems Biology
NIAID/NIH
Bethesda, MD, USA

Martin Meier-Schellersheim
mms@niaid.nih.gov
Laboratory of Systems Biology
NIAID/NIH
Bethesda, MD, USA

Version 1, Release 0.3 (Draft)

Last update: Tuesday 21st April, 2015

This is a draft specification for the SBML Level 3 package called “*Multi*”. It is not a normative document. Please send feedback to the package mailing list at sbml-multi@lists.sourceforge.net.

The latest release, past releases, and other materials related to this specification are available at [http://sbml.org/Documents/Specifications/SBML_Level_3/Packages/Multistate_and_Multicomponent_Species_\(multi\)](http://sbml.org/Documents/Specifications/SBML_Level_3/Packages/Multistate_and_Multicomponent_Species_(multi))

This release of the specification is available at
TBD



Contributors

Fengkai Zhang
Laboratory of Systems Biology
NIAID/NIH
Bethesda, MD, USA

Anika Oellrich
European Bioinformatics Institute
Wellcome Trust Genome Campus
Hinxton, Cambridge, UK

Lucian P. Smith
Computing and Mathematical Sciences
California Institute of Technology
Seattle, Washington, USA

Bastian Angermann
Laboratory of Systems Biology
NIAID/NIH
Bethesda, MD, USA

James Faeder
Department of Computational Biology
University of Pittsburgh School of Medicine
Pittsburgh, PA, USA

Leonard A. Harris
Department of Computational Biology
University of Pittsburgh School of Medicine
Pittsburgh, PA, USA

Stefan Hoops
Virginia Bioinformatics Institute
Virginia Tech
Blacksburg, VA, USA

Michael Hucka
Computing and Mathematical Sciences
California Institute of Technology
Pasadena, CA, USA

Nicolas Rodriguez
European Bioinformatics Institute
Wellcome Trust Genome Campus
Hinxton, Cambridge, UK

Martin Meier-Schellersheim
Laboratory of Systems Biology
NIAID/NIH
Bethesda, MD, USA

Nicolas Le Novère
European Bioinformatics Institute
Wellcome Trust Genome Campus
Hinxton, Cambridge, UK

Michael Blinov
Dept. of Genetics & Developmental Biology
University of Connecticut Health Center
Farmington, CT, USA

Andrew Finney
University Hertfordshire
Hatfield, Herts, UK

William S. Hlavacek
Theoretical Division
Los Alamos National Laboratory
Los Alamos, NM, USA

Bin Hu
Theoretical Division
Los Alamos National Laboratory
Los Alamos, NM, USA

Alida Palmisano
Department of Biological Sciences
Virginia Tech
Blacksburg, VA, USA

And all the people who contributed to the discussions on the sbml-multi mailing list.

Contents

| | |
|---|-----------|
| 1 Introduction | 4 |
| 1.1 Proposal corresponding to this package specification | 4 |
| 1.2 Package dependencies | 4 |
| 1.3 Document conventions | 4 |
| 2 Background and context | 5 |
| 2.1 Past work on this problem or similar topics | 5 |
| 3 Package syntax and semantics | 7 |
| 3.1 Namespace URI and other declarations necessary for using this package | 7 |
| 3.2 Primitive data types | 7 |
| 3.2.1 Type BindingStatus | 7 |
| 3.2.2 Type Relation | 7 |
| 3.2.3 Type RepresentationType | 7 |
| 3.3 The new and extended classes in the Multi Package | 7 |
| 3.4 Model | 9 |
| 3.4.1 ListOfSpeciesTypes | 9 |
| 3.5 Extended Compartment | 10 |
| 3.5.1 The isType attribute | 10 |
| 3.5.2 The compartmentType attribute | 10 |
| 3.5.3 ListOfCompartmentReferences | 10 |
| 3.6 CompartmentReference | 11 |
| 3.6.1 The id and name attributes | 11 |
| 3.6.2 The compartment attribute | 11 |
| 3.7 The relationship of Compartment , CompartmentReference and ListOfCompartmentReferences | 11 |
| 3.8 SpeciesType | 12 |
| 3.8.1 The id and name attributes | 12 |
| 3.8.2 The compartment attribute | 12 |
| 3.8.3 ListOfSpeciesFeatureTypes | 13 |
| 3.8.4 ListOfSpeciesTypeInstances | 13 |
| 3.8.5 ListOfInSpeciesTypeBonds | 13 |
| 3.8.6 ListOfSpeciesTypeComponentIndexes | 13 |
| 3.8.7 BindingSiteSpeciesType | 13 |
| 3.9 SpeciesFeatureType | 14 |
| 3.9.1 The id and name attributes | 14 |
| 3.9.2 The occur attribute | 14 |
| 3.9.3 ListOfPossibleSpeciesFeatureValues | 14 |
| 3.10 PossibleSpeciesFeatureValue | 15 |
| 3.10.1 The id and name attributes | 15 |
| 3.10.2 The numericValue attribute | 15 |
| 3.11 SpeciesTypeInstance | 16 |
| 3.11.1 The id and name attributes | 16 |
| 3.11.2 The speciesType attribute | 16 |
| 3.11.3 The compartmentReference attribute | 16 |
| 3.11.4 The occur attribute | 17 |
| 3.12 SpeciesTypeComponentIndex | 18 |
| 3.12.1 The id attribute | 18 |
| 3.12.2 The component attribute | 18 |
| 3.12.3 The identifyingParent attribute | 19 |
| 3.12.4 The occur attribute | 19 |
| 3.12.5 ListOfDenotedSpeciesTypeComponentIndexes | 20 |
| 3.13 DenotedSpeciesTypeComponentIndex | 21 |
| 3.13.1 The speciesTypeComponentIndex attribute | 21 |
| 3.13.2 Reference a component in a speciesType or a species | 21 |
| 3.14 InSpeciesTypeBond | 22 |
| 3.14.1 The id and name attributes | 22 |
| 3.14.2 The bindingSite1 and bindingSite2 attributes | 22 |
| 3.15 Uniqueness of SpeciesType definitions | 23 |
| 3.16 Species | 25 |
| 3.16.1 The speciesType attribute | 25 |
| 3.16.2 ListOfOutwardBindingSites | 25 |
| 3.16.3 ListOfSpeciesFeatures | 26 |
| 3.17 OutwardBindingSite | 27 |

| | | |
|--------|---|----|
| 3.17.1 | The <code>bindingStatus</code> attribute | 27 |
| 3.17.2 | The <code>component</code> attribute | 27 |
| 3.17.3 | Example | 27 |
| 3.18 | SpeciesFeature | 29 |
| 3.18.1 | The <code>id</code> attribute | 29 |
| 3.18.2 | The <code>speciesFeatureType</code> attribute | 29 |
| 3.18.3 | The <code>occur</code> attribute | 29 |
| 3.18.4 | The <code>component</code> attribute | 30 |
| 3.18.5 | ListOfSpeciesFeatureValues | 30 |
| 3.18.6 | SpeciesFeatureValue | 30 |
| 3.18.7 | Example | 30 |
| 3.19 | "Fully defined" species and the mapping to "pattern" species | 34 |
| 3.20 | Reaction | 35 |
| 3.21 | IntraSpeciesReaction | 35 |
| 3.22 | Extended SimpleSpeciesReference | 36 |
| 3.23 | Extended SpeciesReference | 37 |
| 3.23.1 | ListOfSpeciesTypeComponentMapsInProduct | 37 |
| 3.24 | SpeciesTypeComponentMapInProduct | 38 |
| 3.24.1 | The <code>reactant</code> attribute | 38 |
| 3.24.2 | The <code>reactantComponent</code> attribute | 38 |
| 3.24.3 | The <code>productComponent</code> attribute | 38 |
| 3.24.4 | ListOfSpeciesFeatureChanges | 38 |
| 3.24.5 | Example | 39 |
| 3.25 | SpeciesFeatureChange | 42 |
| 3.25.1 | The <code>id</code> attribute | 42 |
| 3.25.2 | The <code>reactantSpeciesFeature</code> attribute | 42 |
| 3.25.3 | The <code>productSpeciesFeature</code> attribute | 42 |
| 3.25.4 | Example | 42 |
| 3.26 | The <code>outwardBindingSites</code> and <code>speciesFeatures</code> in "don't care" state in a reaction product | 44 |
| 3.27 | Extended <code>ci</code> elements in Math objects | 45 |
| 3.27.1 | The <code>speciesReference</code> attribute | 45 |
| 3.27.2 | The <code>representationType</code> attribute | 46 |
| 3.28 | Namespace scoping rules for identifiers | 48 |
| 4 | Examples | 49 |
| 4.1 | Example: Compartment, SpeciesType and Species | 49 |
| 4.2 | <i>Simmune</i> example: the <i>Ecad</i> model | 50 |
| 4.3 | The "microtubule" example in the previous Multi proposal (2010) | 58 |
| 4.4 | A <i>BioNetGen</i> example from its user manual | 61 |
| 4.5 | Mappings between reactants and products in a published model | 73 |
| 4.6 | Example from <i>Kappa's</i> documentation | 81 |
| A | Validation of SBML documents using Multi constructs | 83 |
| | Acknowledgments | 96 |
| | References | 97 |

1 Introduction

This Multistate, Multicomponent and Multicompartment Species (Multi) package provides an extension of SBML Level 3 [Hucka et al. (2010)] that supports encoding `models` with molecular complexes that have multiple components and can exist in multiple states and in multiple `compartments`. One of its goals also is to provide a platform for sharing `models` based on the specifications of bi-molecular interactions and the rules governing such interactions [Angermann et al. (2012); Feret et al. (2009); Hlavacek et al. (2006); Zhang et al. (2013)]. This specification covers the goals and features described in the previous Multi proposal [Novère and Oellrich (2010)] for extending SBML to carry the information for *multistate multicomponent species* with revised data structure. In addition, this specification includes the feature for *multicompartment species* as described in the most recent releases of the Multi proposal [Zhang and Meier-Schellersheim (2013a), Zhang et al. (2012)].

1.1 Proposal corresponding to this package specification

This specification for Multi in SBML Level 3 Version 1 is mainly based on the new Multi proposal (May 2013, Rev 280) located at the following URL:

<http://goo.gl/2375K>

1.2 Package dependencies

The Multi package has no dependencies on other SBML Level 3 packages.

1.3 Document conventions

UML 1.0 notation is used in this document to define the constructs provided by this package. Colors in the diagrams carry the following additional information for the benefit of those viewing the document on media that can display color:

- **Black** Items colored black are components taken unchanged from their definitions in the SBML Level 3 Core specification document.
- **Green** Items colored green are components that exist in SBML Level 3 Core, but are extended by this package. Class boxes are also drawn with dashed lines to further distinguish them.
- **Blue** Items colored blue are new components introduced in this package specification. They have no equivalent in the SBML Level 3 Core specification.

For other matters involving the use of UML, XML and typographical conventions, this document follows the conventions used in the SBML Level 3 Core specification document [Hucka et al. (2010)].

For simplicity, “...” in all example code refers to some unspecified code content, that is not important for the purpose of illustrating the issue at hand.

2 Background and context

Rule-based modeling approaches (*BioNetGen*[Faeder et al. (2009)], *Kappa*[Danos and Laneve (2004)], and *Simune*[Angermann et al. (2012); Meier-Schellersheim et al. (2006)]) define rules for interactions between pairs of molecule components, specifying how the interactions depend on particular states of the molecules (pattern) and their locations in specific compartments. In order to generate networks of biochemical reactions these rules are applied to the molecular components of the systems to be modeled, either at the beginning of the modeling (simulation) process or “on the fly” (as molecule complexes emerge from the interaction rules). Expressing such rule-based reaction networks using the concepts of **Species** and **Compartment** in SBML (L3 core and L2) can be difficult for rules and molecule sets that lead to large numbers of resulting molecular complexes. It would therefore be desirable to have an SBML standard for encoding rule-based `models` using their “native” concepts for describing reactions instead of having to apply the rules and unfold the networks prior to encoding in an SBML format.

We proposed a revised proposal of the Multi: “Multistate, Multicomponent and Multicompartment Species Package for SBML Level 3” (abbreviated as Multi)[Zhang et al. (2012) and Zhang and Meier-Schellersheim (2013a)] which takes the previous Multi proposal [Novère and Oellrich (2010)] as base and addresses some issues arising from a rule-based modeling point of view. **This specification documentation has been developed from the most recent release of the Multi specification in Sept 2013 [Rev 369, Zhang and Meier-Schellersheim (2013b)] with several new or updated features, including:**

- A new **BindingSiteSpeciesType** sub-class inheriting the **SpeciesType** class for binding sites. Accordingly, the **isBindingSite** attribute has been dropped from **SpeciesType**.
- **Restriction on binding sites which have to be atomic (References: Section 3.8.7 on page 13).**
- A new **IntraSpeciesReaction** sub-class inheriting the **Reaction** class for the reactions happening within a **Species** object. Accordingly, the **isIntraSpeciesReaction** attribute has been dropped from **Reaction**.
- **Validation rules. (References: Section A on page 83)**

2.1 Past work on this problem or similar topics

- Nicolas Le Novère and Anika Oellrich proposed the previous Multi proposal (2010). That proposal provides a history of the development of the Multi package before 2010:
 - Andrew Finney was probably the first to formulate, in March 2001, proposed SBML extensions to support complex species, to be able to cover multistates species and species made up of graphs of components, as part of a collection of proposals for new SBML development. At the 3rd Workshop on Software Platforms for Systems Biology in June 2001, Nicolas Le Novère gave a presentation entitled Multistate molecules and complex objects proposing to extend Andrew’s multistate proposal.
 - Nicolas Le Novère and Tom Shimizu came up in July 2001 with an alternative proposal for encoding and using states in SBML. A slightly extended and corrected version of this proposal presented by Nicolas at the 5th Workshop on Software Platforms for Systems Biology in July 2002. Nicolas Le Novère, Tom Shimizu and Andrew Finney published a complete description of this extension in December 2002.
 - In March 2004, before the 2nd SBML hackathon, Andrew Finney published an updated proposal to encode complex species made up of several components. Planed as an extension for SBML Level 3, the document also described `SpeciesTypes` that would later be incorporated to SBML Level 2, from version 2 onward.
 - In October 2004, Michael Blinov published, together with Jim Fader, Byron Goldstein, Andrew Finney and Bill Hlavacek, an alternative proposal for encoding multi-component species, that also contained some possibilities of encoding multistate features.

- Anika Oellrich started to implement a new SBML L2 support for StochSim in spring 2007, storing multistate information in proprietary annotations. This led in June 2007 to a proposal for Level 3 by Le Novegravere and Oellrich, meant to work in conjunction with 2004 Finney’s multicomponents proposal. The proposal was presented at the 12th SBML forum meeting. A light correction was published in December 2007.
 - Also at the 12th SBML forum meeting, Michael Blinov presented an updated version of his proposal. He later published two proposals for SBML L3, one with a hierarchical speciesTypes structure and one with a non-hierarchical speciesTypes structure.
 - On December 6 and 7, 2007, an SBML Focused Videoconference was held, which launched the effort to develop the Level 3 package Multi.
- In August 2012, Fengkai Zhang from the *Simmune* group presented “Draft for discussion SBML Proposals for Revised Multi, Simple Spatial and Multi-Spatial Extensions” at COMBINE 2012 [Zhang et al. (2012)]. The three proposals cover the goals and scope of the previous Multi proposal (2010), revise it and add some new features that improve usage of the proposal for rule-based approaches.
 - Based on the discussions and suggestions received during COMBINE 2012 as well as on feedback from the SBML discussion forum, the new Multi proposal [Rev 221, Zhang and Meier-Schellersheim (2012)] was released to the SBML-Multi community, which integrates and covers most of the features in the three previous proposals of Aug 2012.
 - In May 2013, a new reversion of the Multi proposal [Zhang and Meier-Schellersheim (2013a)] was released before the meeting of HARMONY 2013. The extended **Compartment** class and its related classes have been reorganized. All optional boolean attributes have been removed/replaced. A new optional Multi attribute, “**whichValue**”, was added to the **ci** elements in **KineticLaw** to identify the sources of **species**. (Lucian Smith gave many comments/suggestions about this proposal and Willam Hlavacek gave thoughtful feedback about the *BioNetGen* example in this proposal). This revision 280 was presented at HARMONY 2013 [Zhang and Meier-Schellersheim (2013c)] with new features to configure multiple occurrences of **SpeciesFeatureType**. Several new or revised features were discussed during and after HARMONY 2013, including multiple occurrences of **SpeciesFeatureType**, multiple copies of **SpeciesTypeInstance**, the **numericValue** attribute for **PossibleSpeciesFeatureValue** and concentration summation of pattern **species**. These features are covered or updated in this specification.
 - A draft specification was released in Sep 2013 [Rev 369, Zhang and Meier-Schellersheim (2013b)] and was presented in COMBINE 2013 [Zhang and Meier-Schellersheim (2013d)]. This version of the specification addresses the scenario of multiple occurrences of identical components and/or identical features.
 - In COMBINE 2014, a discussion of the Multi package focused on how to facilitate tools to export and import **models** encoded in the Multi format [Zhang and Meier-Schellersheim (2014)] .

3 Package syntax and semantics

This section contains a definition of the syntax and semantics of the Multi package for SBML Level 3 Core.

3.1 Namespace URI and other declarations necessary for using this package

The following is the namespace URI for this version of the Multi package for SBML Level 3 Core:

```
"http://www.sbml.org/sbml/level3/version1/multi/version1"
```

In addition, SBML documents using a given package must indicate whether the package can be used to change the mathematical interpretation of a model. This is done using the attribute **required** on the `<sbml>` element in the SBML document. For the Multi package, the value of this attribute must be **"true"**.

The following fragment illustrates the beginning of a typical SBML model using SBML Level 3 Core and this version of the Multi package:

```
<?xml version="1.0" encoding="UTF-8"?>
<sbml xmlns="http://www.sbml.org/sbml/level3/version1/core" level="3" version="1"
  xmlns:multi="http://www.sbml.org/sbml/level3/version1/multi/version1" multi:required="true">
```

3.2 Primitive data types

The Multi package uses a number of the primitive data types described in [Section 3.1](#) of the SBML Level 3 Core [[Hucka et al. \(2010\)](#)] specification such as `SID`, `SIDRef`, `string`, `boolean`, `int` and `positiveInteger`, and adds three additional primitive types described below.

3.2.1 Type BindingStatus

The `BindingStatus` primitive data type is used in the definition of the `OutwardBindingSite` class. `BindingStatus` is derived from type `string` and its values are restricted to be one of the following possibilities: **"bound"**, **"unbound"**, and **"either"**. Attributes of type `BindingStatus` cannot take on any other values. The meaning of these three values is discussed in the context of the `OutwardBindingSite` class in [Section 3.17 on page 27](#).

3.2.2 Type Relation

The `Relation` primitive data type is used in the definition of the `ListOfSpeciesFeatures` class. `Relation` is derived from type `string` and its values are restricted to be one of the following possibilities: **"and"**, **"or"**, and **"not"**. Attributes of type `Relation` cannot take on any other values. The meaning of these three values is discussed in the context of the `ListOfSpeciesFeatures` class in [Section 3.16.3 on page 26](#).

3.2.3 Type RepresentationType

The `RepresentationType` primitive data type is used in the extension of the `ci` element. `RepresentationType` is derived from type `string` and its values are restricted to be one of the following possibilities: **"sum"** or **"numericValue"**. If present, attributes of type `RepresentationType` cannot take on any other values. The meaning of these three values is discussed in the context of the `ci` element in [Section 3.27 on page 45](#).

3.3 The new and extended classes in the Multi Package

The Multi package defines or extends the following object classes, `Model`, `ListOfSpeciesTypes`, `Compartment`, `ListOfCompartmentReferences`, `CompartmentReference`, `SpeciesType`, `ListOfSpeciesTypeInstances`, `ListOfSpeciesFeatureTypes`, `ListOfInSpeciesTypeBonds`, `ListOfSpeciesTypeComponentIndexes`, `SpeciesFeatureType`, `ListOfPossibleSpeciesFeatureValues`, `PossibleSpeciesFeatureValue`, `SpeciesTypeInstance`, `InSpeciesTypeBond`, `SpeciesTypeComponent-`

[Index](#), [ListOfDenotedSpeciesTypeComponentIndexes](#), [DenotedSpeciesTypeComponentIndex](#), [Species](#), [ListOfOutwardBindingSites](#), [ListOfSpeciesFeatures](#), [OutwardBindingSite](#), [SpeciesFeature](#), [ListOfSpeciesFeatureValues](#), [SpeciesFeatureValue](#), [Reaction](#), [SimpleSpeciesReference](#), [SpeciesReference](#), [ListOfSpeciesTypeComponentMapsInProduct](#), [SpeciesTypeComponentMapInProduct](#), [ListOfSpeciesFeatureChanges](#), and [SpeciesFeatureChange](#).

All the classes in the Multi package are directly or indirectly derived from ***SBase***, and ***SBase*** provides the ability to attach SBO terms as well as MIRIAM annotations, the semantics of a given class in the Multi package can be made more precise by referencing to external controlled vocabularies and ontologies.

Like the classes in SBML Level 3 Core, most new Multi classes have the attribute **id** (typically mandatory but not all, and of type **SId**), which serves as an identifier to provide a way to identify the class object. The identifier of a class object reference may or may not carry mathematical interpretation or be used in mathematical formulas, depending on its class and the class object referencing it. **The scope of *ids* is described in the section of “Namespace scoping rules for identifiers” (Section 3.28 on page 48).**

3.4 Model

The Multi package extends the **Model** class of SBML Level 3 Core and adds an optional **ListOfSpeciesTypes** child to **Model**. Figure 1 provides the UML diagram for the extended **Model** class.

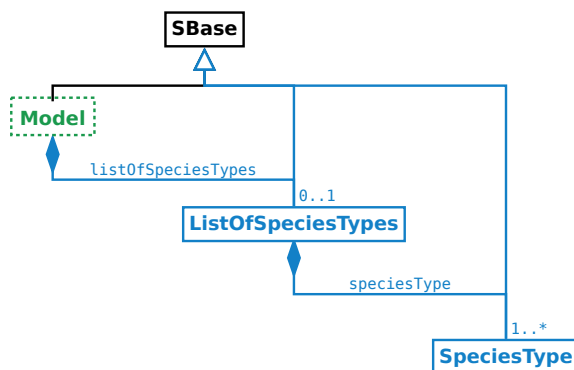

Figure 1: The extension of the **Model** class.

3.4.1 ListOfSpeciesTypes

ListOfSpeciesTypes is defined in Figure 1. If present, a **ListOfSpeciesTypes** object must contain at least one **SpeciesType** object. Since **ListOfSpeciesTypes** is derived from **SBBase**, it inherits the **sboTerm** and **metaid** attributes, as well as the optional children **Notes** and **Annotation** objects.

3.5 Extended **Compartment**

A **Compartment** object in SBML Level 3 Core represents a bounded space in which *species* are located. In the Multi package, **Compartment** is extended. A Multi **compartment** can be a **type** that multiple referencing **compartments** can map to. A Multi **compartment** can also be a composite **compartment** or a container that includes other **compartments**.

The extension of **Compartment** is defined in Figure 2. The extended **Compartment** class has a new required attribute **isType**, a new optional attribute **compartmentType** and an optional **ListOfCompartmentReferences** child. The example at Section 4.1 on page 49 illustrates the use of the extended **Compartment** class.

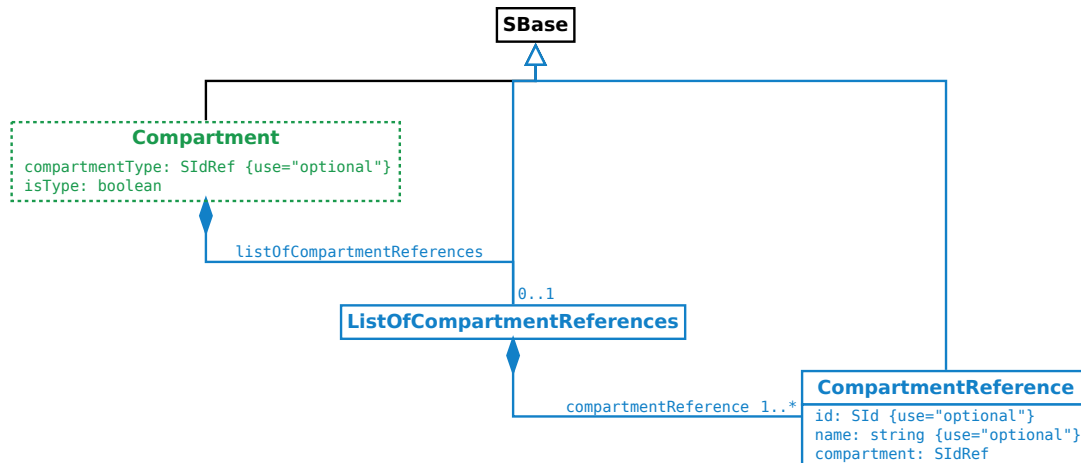

Figure 2: The definitions of **Compartment**, **ListOfCompartmentReferences** and **CompartmentReference**

3.5.1 The **isType** attribute

The required attribute **isType**, of type **boolean**, on the **Compartment** class serves to provide a way to indicate whether the **Compartment** object is a compartment type.

A **Compartment** object is a compartment type if the value of its **isType** attribute is “**true**”. A **compartment type** is a template (in the sense of prototype) for all **Compartment** objects referencing it (via **compartmentType** attributes). A **Species** object directly referencing a compartment type is not a “**fully defined**” species (see Section 3.19 on page 34).

If the value of the **isType** attribute is “**false**”, the **Compartment** object is a “**not-a-type**” *compartment*, and it is similar to a SBML core **compartment** except it can reference a compartment type and can have a **ListOfCompartmentReferences** child.

3.5.2 The **compartmentType** attribute

The optional attribute **compartmentType**, of type **SIIDRef**, is used for a “**not-a-type**” **compartment** to reference a compartment type. A **compartment** with the “**true**” value of its **isType** attribute can not have the **compartmentType** attribute defined.

3.5.3 **ListOfCompartmentReferences**

ListOfCompartmentReferences is defined in Figure 2, and must have one or more **CompartmentReference** children. Since **ListOfCompartmentReferences** is derived from **SBase**, it inherits the **sboTerm** and **metaid** attributes, as well as the optional children **Notes** and **Annotation** objects.

3.6 `CompartmentReference`

`CompartmentReference` is defined in [Figure 2 on the previous page](#). It has two optional attributes `id` and `name`, and a required attribute `compartment`. Since `CompartmentReference` is derived from `SBase`, it inherits the `sboTerm` and `metaid` attributes, as well as the optional children `Notes` and `Annotation` objects.

3.6.1 *The id and name attributes*

The optional `id` attribute, of type `SId`, serves to provide a way to identify a `compartmentReference`. `CompartmentReference` also has an optional `name` attribute, of type `string`.

If some or all `compartmentReferences` within a `ListOfCompartmentReferences` object reference the same `compartment`, those `compartmentReferences` are required to have their `id` attributes defined to distinguish different `compartmentReferences`.

3.6.2 *The compartment attribute*

The required `compartment` attribute, of type `SIdRef`, serves to provide a way to reference a `Compartment` object.

3.7 The relationship of `Compartment`, `CompartmentReference` and `ListOfCompartmentReferences`

In a `ListOfCompartmentReferences` object, every children `compartmentReferences` must exclusively reference, directly or indirectly, “not-a-type” `compartment` which can be of the same `compartment` type. See the extended `Compartment` objects in the example in [Section 4.1 on page 49](#).

All `compartments` referenced by a `listOfCompartmentReferences` must have the values of their `isType` attributes the same as that in the parent `compartment` of the `listOfCompartmentReferences`. For example, a `compartment` “A” with `isType=“true”` has a `listOfCompartmentReferences` referencing two `compartments` “A1” and “A2”. Then, “A1” and “A2” must have `isType=“true”`.

3.8 SpeciesType

SpeciesType is defined in Figure 3 and serves to provide backbone structures for **species**. **SpeciesType** has one required attribute, **id**, two optional attributes, **name** and **compartment** and four optional **ListOf__** objects of **ListOfSpeciesFeatureTypes**, **ListOfSpeciesTypeInstances**, **ListOfInSpeciesTypeBonds** and **ListOfSpeciesTypeComponentIndexes** respectively. Since **SpeciesType** is derived from **SBase**, it inherits the **sboTerm** and **metaId** attributes, as well as the optional children **Notes** and **Annotation** objects.

The **ListOfSpeciesTypeInstances** subobject provides a way to define multicomponents which are instances of other **SpeciesType** objects. The **ListOfSpeciesFeatureTypes** subobject and its **SpeciesFeatureType** children set up a framework for the referencing **species** or the instances of **speciesTypes** to be able to have multistates. The **ListOfSpeciesTypeComponentIndexes** subobject provides a flexible way to reference any component in a **speciesType**.

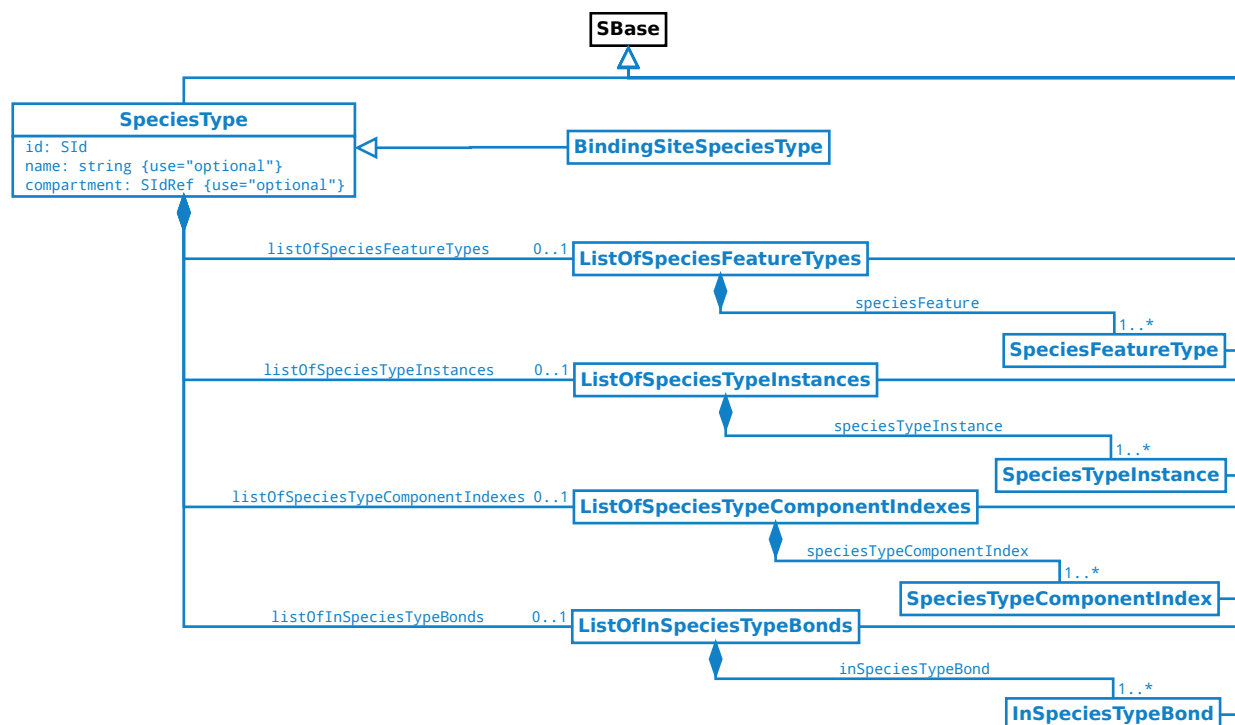

Figure 3: The definition of the **SpeciesType** class.

3.8.1 The id and name attributes

The required **id** attribute, of type **SId**, serves to provide a way to identify a **speciesType**. **SpeciesType** also has an optional **name** attribute, of type **string**.

3.8.2 The compartment attribute

SpeciesType has an optional attribute **compartment**, of type **SIdRef**, to be used to identify the **compartment** where the **speciesType** is located. The attribute value must be the identifier of an existing **compartment** in the **model**. If present, it must be consistent with the **compartment** attributes of the referencing **species** (see Section 3.16 on page 25) and the **compartmentReference** attributes of its instances (see Section 3.11.3 on page 16). The example in Section 4.1 on page 49 illustrates how to keep the consistency of this attribute.

3.8.3 ListOfSpeciesFeatureTypes

ListOfSpeciesFeatureTypes is defined in Figure 3 on the previous page, and, if present, must have one or more **SpeciesFeatureType** children. Since **ListOfSpeciesFeatureTypes** is derived from **SBase**, it inherits the **sboTerm** and **metaid** attributes, as well as the optional children **Notes** and **Annotation** objects.

3.8.4 ListOfSpeciesTypeInstances

ListOfSpeciesTypeInstances is defined in Figure 3 on the preceding page, and, if present, must have one or more **SpeciesTypeInstance** children. Since **ListOfSpeciesTypeInstances** is derived from **SBase**, it inherits the **sboTerm** and **metaid** attributes, as well as the optional children **Notes** and **Annotation** objects.

3.8.5 ListOfInSpeciesTypeBonds

ListOfInSpeciesTypeBonds class is defined in Figure 3 on the previous page, and, if present, must have one or more **InSpeciesTypeBond** children. Since **ListOfInSpeciesTypeBonds** is derived from **SBase**, it inherits the **sboTerm** and **metaid** attributes, as well as the optional children **Notes** and **Annotation** objects.

3.8.6 ListOfSpeciesTypeComponentIndexes

ListOfSpeciesTypeComponentIndexes is defined in Figure 3 on the preceding page, and, if present, must have one or more **SpeciesTypeComponentIndex** children. Since **ListOfSpeciesTypeComponentIndexes** is derived from **SBase**, it inherits the **sboTerm** and **metaid** attributes, as well as the optional children **Notes** and **Annotation** objects.

3.8.7 BindingSiteSpeciesType

BindingSiteSpeciesType inherits the **SpeciesType** class and is defined in Figure 3 on the previous page. A **BindingSiteSpeciesType** object is a **binding site**, and therefore its instance can further define the **bindingStatus** attribute and can participate a binding internally and explicitly in an **InSpeciesTypeBond** object, or externally and implicitly defined by an **OutwardBindingSite** object. A **binding site** must be an atomic component which means that a **BindingSiteSpeciesType** object can not contain a **ListOfSpeciesTypeInstances** subobject.

 *Note:*

*In the Multi package, a **binding site** can participate one binding at a time. That means a **binding site** can not bind two partners at the same time. The binding relationship is one-to-one.*

3.9 SpeciesFeatureType

SpeciesFeatureType is defined in Figure 4, and serves to provide frameworks or templates to define the referencing **SpeciesFeature** objects. **SpeciesFeatureType** has two required attributes **id** and **occur**, an optional attribute **name**, and a required child **listOfPossibleSpeciesFeatureValues**. The multiple possibleSpeciesFeatureValues of the **ListOfPossibleSpeciesFeatureValues** object permit constructing multistate species via its speciesFeatures under the **ListOfSpeciesFeatures** object. Since **SpeciesFeatureType** is derived from **SBase**, it inherits the **sboTerm** and **metaid** attributes, as well as the optional children **Notes** and **Annotation** objects.

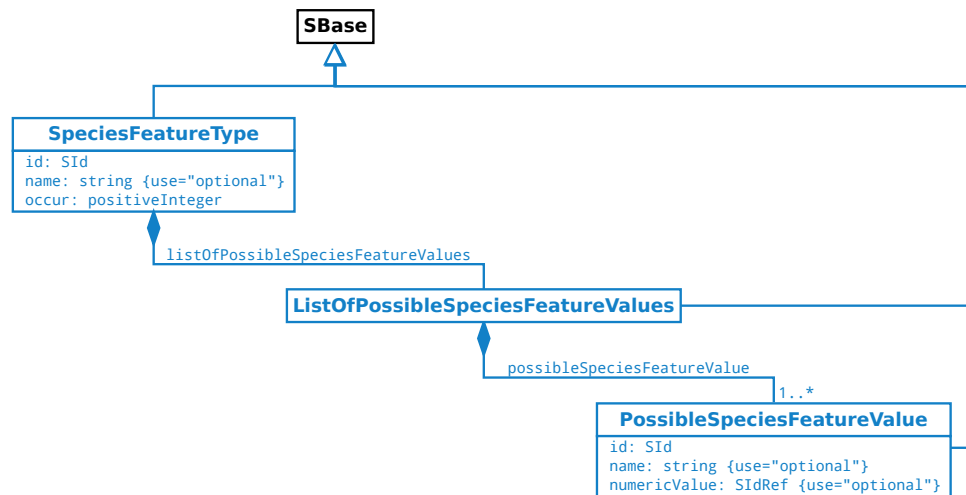

Figure 4: The definitions of **SpeciesFeatureType**, **ListOfPossibleSpeciesFeatureValues** and **PossibleSpeciesFeatureValue** classes.

3.9.1 The id and name attributes

The required **id** attribute, of type **SId**, serves to provide a way to identify a **speciesFeatureType**. Its value must be unique within its direct parent **speciesType**. When a **speciesFeatureType** is referenced by a **speciesFeature**, a **SpeciesTypeComponentIndex** object indexing the containing component can be used to avoid ambiguity. See the example in Section 3.24.5 on page 39.

SpeciesFeatureType also has an optional **name** attribute, of type **string**.

3.9.2 The occur attribute

SpeciesFeatureType has a required attribute **occur**, of type **positiveInteger**, used to indicate the number of instances of the **speciesFeatureType**. This attribute can be used to infer the number of the instances in “don’t care” state with the use of the **occur** attribute in a referencing **speciesFeature** (also see Section 3.18.3 on page 29).

3.9.3 ListOfPossibleSpeciesFeatureValues

ListOfPossibleSpeciesFeatureValues is defined in Figure 4, and must have one or more **PossibleSpeciesFeatureValue** children. Since **ListOfPossibleSpeciesFeatureValues** is derived from **SBase**, it inherits the **sboTerm** and **metaid** attributes, as well as the optional children **Notes** and **Annotation** objects.

3.10 PossibleSpeciesFeatureValue

PossibleSpeciesFeatureValue is defined in [Figure 4 on the preceding page](#), and is used to define the possible values a **speciesFeature** can take. It has a required attribute **id** and two optional attributes **name** and **numericValue**. Since **PossibleSpeciesFeatureValue** is derived from **SBase**, it inherits the **sboTerm** and **metaid** attributes, as well as the optional children **Notes** and **Annotation** objects.

3.10.1 The id and name attributes

The required **id** attribute, of type **SId**, serves to provide a way to identify a **possibleSpeciesFeatureValue**. Its value must be unique within the containing **speciesType**.

If the **id** of a **possibleSpeciesFeatureValue** is the content of a **ci** element in a MathML expression, it can either represent the **numericValue** (when the **ci** has **representationType**="numericValue") or the count of the feature instances (default) which have this value. Also see the example at [Section 3.27.2 on page 46](#).

PossibleSpeciesFeatureValue also has an optional **name** attribute, of type **string**.

3.10.2 The numericValue attribute

PossibleSpeciesFeatureValue has an optional attribute **numericValue** to be used to provide a reference to a numeric value that the **PossibleSpeciesFeatureValue** object can have. This attribute has type of **SIdRef**, and the value must be the identifier of a **Parameter** object in the **model**. The numeric value along with the unit can be defined in the **Parameter** object.

The modeler can either use the identifier of the **parameter**, or the identifier of the **possibleSpeciesFeatureValue** (with **ci**'s **representationType** and **speciesReference** attribute) as the content of a **ci** element to represent its value in MathML expressions in SBML.

3.11 SpeciesTypeInstance

SpeciesTypeInstance serves to provide a way to construct **speciesTypes** and **species** with multiple components. A **speciesType** can contain a list of instances of other **speciesTypes** which can also have their own **speciesTypeInstances**, so the complete structure of a **speciesType** can be like a tree. A **speciesType** can not contain an instance of any other **speciesType** that already contains the instance of it. In other words, circular references are not allowed when constructing **speciesTypes**. For example, if a **speciesType** “A” contains the instance of another **speciesType** “B”, “B” must not contain the instance of “A” anywhere in the complete structure of “B”.

SpeciesTypeInstance is defined in Figure 5. It has three required attributes, **id**, **speciesType** and **occur**, and two optional attributes **name** and **compartmentReference**. Since **SpeciesTypeInstance** is derived from **SBase**, it inherits the **sboTerm** and **metaid** attributes, as well as the optional children **Notes** and **Annotation** objects.

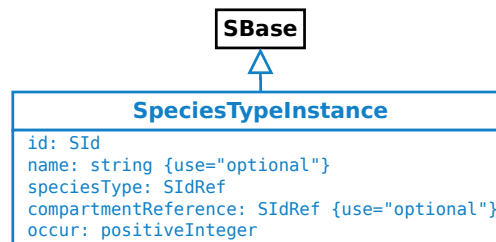

Figure 5: The definition of the **SpeciesTypeInstance** class

3.11.1 The id and name attributes

The required **id** attribute, of type **SId**, serves to provide a way to identify a **speciesTypeInstance**. Its value must be unique within its direct parent **speciesType**.

SpeciesTypeInstance also has an optional **name** attribute of type **string**.

3.11.2 The speciesType attribute

SpeciesTypeInstance has a required attribute **speciesType**, of type **SIdRef**, is used to reference a **speciesType**.

3.11.3 The compartmentReference attribute

SpeciesTypeInstance has an optional attribute **compartmentReference**, of type **SIdRef**, can be used to indicate which sub-compartment in a composite **compartment** the **speciesTypeInstance** is located in.

For example, a compartment “cA” has two sub-compartments “cB1” (referenced by **compartmentReference** “crB1”) and “cB2” (referenced by **compartmentReference** “crB2”) of the same compartment type “cB”. A **speciesType** “stA” has two **speciesTypeInstances** “stiB1” and “stiB2” of the same **speciesType** “stB”. The **speciesType** “stA” references the compartment “cA” and the **speciesType** “stB” references the compartment “cB”. The **speciesTypeInstance** “stiB1” is located in “cB1” via the **compartmentReference** “crB1” and the **speciesTypeInstance** “stiB2” is located in “cB2” via the **compartmentReference** “crB2”. The SBML code can be as follows:

```

<listOfCompartments>
  <compartment id="cB" multi:isType="true" ... />
  <compartment id="cB1" multi:isType="false" multi:compartmentType="cB" ... />
  <compartment id="cB2" multi:isType="false" multi:compartmentType="cB" ... />
  <compartment id="cA" multi:isType="false" ... >
    <multi:listOfCompartmentReferences>
      <multi:compartmentReference multi:id="crB1" multi:compartment="cB1" />
      <multi:compartmentReference multi:id="crB2" multi:compartment="cB2" />
    </multi:listOfCompartmentReferences>
  </compartment>

```

```

</listOfCompartments>
<multi:listOfSpeciesTypes>
  <multi:speciesType multi:id="stB" multi:compartment="cB" ... />
  <multi:speciesType multi:id="stA" multi:compartment="cA" ... >
    <multi:listOfSpeciesTypeInstances>
      <multi:speciesTypeInstance multi:id="stiB1" multi:speciesType="stB"
        multi:compartmentReference="crB1" ... />
      <multi:speciesTypeInstance multi:id="stiB2" multi:speciesType="stB"
        multi:compartmentReference="crB2" ... />
    </multi:listOfSpeciesTypeInstances>
  </multi:speciesType>
</multi:listOfSpeciesTypes>

```

3.11.4 The occur attribute

SpeciesTypeInstance has a required attribute **occur**, of type **positiveInteger**, is used to indicate the total number of occurrences of the same **speciesTypeInstance**. In the most cases, the value of this attribute will be “1”. If the value is more than “1”, different occurrences may have different binding status (if the referenced **speciesType** is a binding site) and/or **speciesFeatures** in a referencing **species** with the use of the **occur** attributes in the corresponding **SpeciesTypeComponentIndex** objects.

3.12 SpeciesTypeComponentIndex

SpeciesTypeComponentIndex provides a way to identify or index a **component** within a **speciesType**. A **SpeciesTypeComponentIndex** object can be referenced by other class objects, such as **InSpeciesTypeBond**, **OutwardBindingSite**, **SpeciesFeature** or **SpeciesTypeComponentMapInProduct** objects, which needs to identify a component in a particular **speciesType**.

SpeciesTypeComponentIndex is defined in Figure 6. It has three required attributes, **id**, **component** and **occur**, and an optional attribute **identifyingParent**. Since **SpeciesTypeComponentIndex** is derived from **SBase**, it inherits the **sboTerm** and **metaid** attributes, as well as the optional children **Notes** and **Annotation** objects.

SpeciesTypeComponentIndex has an optional **listOfDenotedSpeciesTypeComponentIndexes** child. The **ListOfDenotedSpeciesTypeComponentIndexes** subobject, if present, specifies a group of **speciesTypeComponentIndexes** that permit this **speciesTypeComponentIndex** to select from.

A **speciesTypeComponentIndex** can have a **ListOfDenotedSpeciesTypeComponentIndexes** child only when the value of the **occur** attribute of the indexed **speciesTypeInstance** component is larger than “1”.

When a **speciesTypeInstance** has multiple occurrences (**occur** > “1”), all referencing **SpeciesTypeComponentIndex** objects with the same **identifyingParent** and with no **ListOfDenotedSpeciesTypeComponentIndexes** object within the **speciesType** are mutually exclusive (ensuring unique indexing). See the examples in Section 4.4 on page 61 and Section 4.5 on page 73.

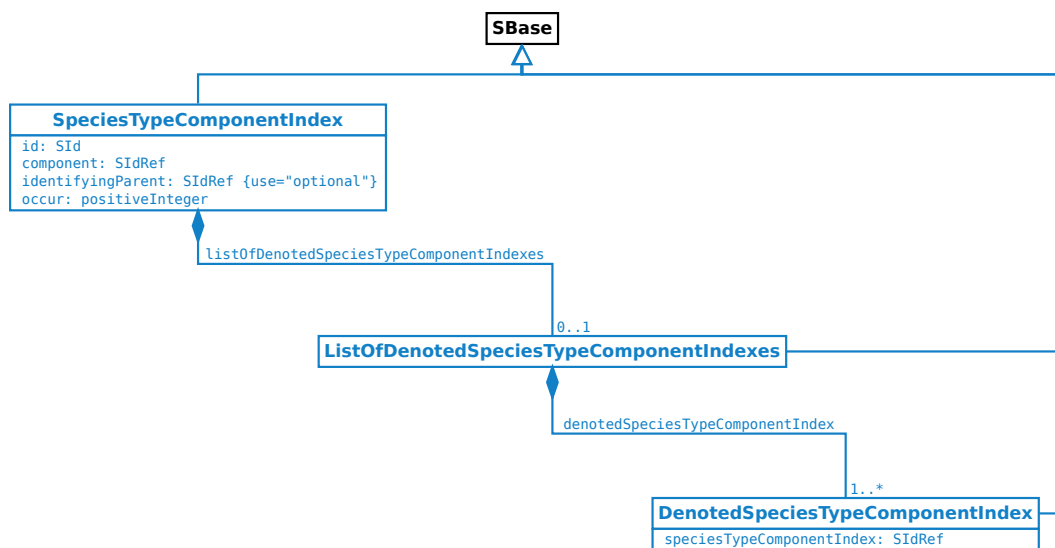

Figure 6: The definitions of the **SpeciesTypeComponentIndex** class and the **DenotedSpeciesTypeComponentIndex** class

3.12.1 The id attribute

The **id** attribute, of type **SId**, provides a way to identify a **speciesTypeComponentIndex**. The value must be unique within the direct parent **speciesType**.

3.12.2 The component attribute

The **component** attribute, of type **SIdRef**, references a **speciesTypeInstance** in the **speciesType**, or the **speciesType** itself. The value of this attribute can be the **id** of a **speciesTypeInstance** or a **speciesTypeComponentIndex** that is defined in the **speciesType** of a **speciesTypeInstance**. If the **component** attribute takes the **id** of another **speciesTypeComponentIndex**, their **occur** attributes must have the same value and the referenc-

ing `speciesTypeComponentIndex` can not define a [ListOfDenotedSpeciesTypeComponentIndexes](#) object (but the referenced `speciesTypeComponentIndex` can). The example in [Section 3.24.5 on page 39](#) illustrates the use of the `component` attribute.

3.12.3 The identifyingParent attribute

The `component` attribute itself may not be sufficient to uniquely reference a component in a `speciesType`. The `identifyingParent` attribute provides assistance for the identification of a `component`. It references a parent of the component and the value can be the `id` of an object of [SpeciesTypeInstance](#), [SpeciesTypeComponentIndex](#) or [SpeciesType](#).

This example illustrates the use of the `identifyingParent` attribute. There are three `speciesTypes` “`stA`”, “`stB`” and “`stC`”. The `speciesType` “`stB`” contains two `speciesTypeInstances` “`C1`” and “`C2`” of the same `speciesType` “`stC`”. The `speciesType` “`stA`” contains two `speciesTypeInstances` “`B1`” and “`B2`” of the same `speciesType` “`stB`”. The `speciesType` “`A`” may be required to index every “`C1`” and “`C2`” by its [ListOfInSpeciesTypeBonds](#) child or referencing `species`. The following SBML code demonstrates how to do the indexing with assistance from the `identifyingParent` attribute.

```
<multi:listOfSpeciesTypes>
  <multi:speciesType multi:id="stC" ... />
  <multi:speciesType multi:id="stB" ... >
    <multi:listOfSpeciesTypeInstances>
      <multi:speciesTypeInstance multi:id="C1" multi:speciesType="stC" multi:occur="1" />
      <multi:speciesTypeInstance multi:id="C2" multi:speciesType="stC" multi:occur="1" />
    </multi:listOfSpeciesTypeInstances>
  </multi:speciesType>
  <multi:speciesType multi:id="stA" ... >
    <multi:listOfSpeciesTypeInstances>
      <multi:speciesTypeInstance multi:id="B1" multi:speciesType="stB" multi:occur="1" />
      <multi:speciesTypeInstance multi:id="B2" multi:speciesType="stB" multi:occur="1" />
    </multi:listOfSpeciesTypeInstances>
    <multi:listOfSpeciesTypeComponentIndexes>
      <multi:speciesTypeComponentIndex multi:id="B1C1"
        multi:component="C1" multi:identifyingParent="B1" multi:occur="1" />
      <multi:speciesTypeComponentIndex multi:id="B1C2"
        multi:component="C2" multi:identifyingParent="B1" multi:occur="1" />
      <multi:speciesTypeComponentIndex multi:id="B2C1"
        multi:component="C1" multi:identifyingParent="B2" multi:occur="1" />
      <multi:speciesTypeComponentIndex multi:id="B2C2"
        multi:component="C2" multi:identifyingParent="B2" multi:occur="1" />
    </multi:listOfSpeciesTypeComponentIndexes>
    ...
  </multi:speciesType>
  ...
</multi:listOfSpeciesTypes>
```

In the `speciesType` “`stA`”, “`B1C1`” identifies the “`C1`” in “`B1`” and “`B2C1`” identifies the “`C1`” in “`B2`”. Similarly, “`B1C2`” identifies the “`C2`” in “`B1`” and “`B2C2`” identifies “`C2`” in “`B2`”.

3.12.4 The occur attribute

`SpeciesTypeComponentIndex` has a required attribute `occur`, of type `positiveInteger`, used to indicate the number of occurrences of the indexed `component`. When the indexed component is a `speciesTypeInstance` with `occur="1"`, the value of this `occur` attribute must be “1”. If the indexed component is a `speciesTypeInstance` with multiple occurrences, the value of this `occur` attribute must be less than or equal to the value of the `occur` attribute of the indexed `speciesTypeInstance`.

3.12.5 ListOfDenotedSpeciesTypeComponentIndexes

ListOfDenotedSpeciesTypeComponentIndexes is defined in Figure 6 on page 18, and must have one or more DenotedSpeciesTypeComponentIndex children. Since ListOfDenotedSpeciesTypeComponentIndexes is derived from SBase, it inherits the sboTerm and metaid attributes, as well as the optional children Notes and Annotation objects.

1
2
3
4
5

3.13 DenotedSpeciesTypeComponentIndex

DenotedSpeciesTypeComponentIndex can be used to define a `listOfDenotedSpeciesTypeComponentIndexes` for a `speciesTypeComponentIndex`. **DenotedSpeciesTypeComponentIndex** has only one required attribute `speciesTypeComponentIndex`. Since **DenotedSpeciesTypeComponentIndex** is derived from **SBase**, it inherits the `sboTerm` and `metaid` attributes, as well as the optional children **Notes** and **Annotation** objects.

3.13.1 The speciesTypeComponentIndex attribute

The required `speciesTypeComponentIndex` attribute, of type `SIIdRef`, is used to reference a `speciesTypeComponentIndex` that must partially (the `occur` of the `speciesTypeComponentIndex` is less than the `occur` of the indexed `speciesTypeInstance` component) reference the same `speciesTypeInstance`.

3.13.2 Reference a component in a speciesType or a species

In the `Multi` package, a component of a `speciesType` may be a `speciesTypeInstance` in the `speciesType` or the `speciesType` itself. This permits, for example, to define the `bindingStatus` of a binding site which may be a `speciesTypeInstance` in a `species` or a `speciesType` directly referenced by a `species`. The second case will be to reference a `speciesFeatureType` of a `speciesTypeInstance` in a `speciesType` or a `speciesType` itself.

In many cases, to reference a component, the `id` of the component will be sufficient and it is not necessary to create an index (`speciesTypeComponentIndex`). The example in [Section 3.12.3 on page 19](#) illustrates two equivalent ways to reference a component, for example, the “B1” component in the “stA” `speciesType`. There are two situations in which the creation of a `speciesTypeComponentIndex` cannot be avoided:

- A `speciesType` (indirectly) has two `speciesTypeInstances` that have the same `id`.
- The `occur` of a `speciesTypeInstance` is larger than “1”.

3.14 InSpeciesTypeBond

An **InSpeciesTypeBond** object defines a bond existing within a **speciesType**. The bond therefore exists in every **species** that references the **speciesType**.

InSpeciesTypeBond is defined in Figure 7. It has two optional attributes, **id** and **name**, and two required attributes, **bindingSite1** and **bindingSite2**. Since **InSpeciesTypeBond** is derived from **SBase**, it inherits the **sboTerm** and **metaid** attributes, as well as the optional children **Notes** and **Annotation** objects.

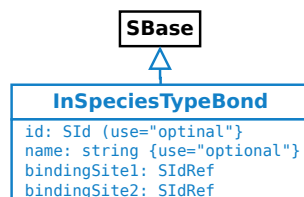

Figure 7: The definition of the **InSpeciesTypeBond** class

3.14.1 The id and name attributes

The optional **id** attribute, of type **SId**, provides a way to identify an **inSpeciesTypeBond**. If present, the value of the **id** attribute must be unique within its directly parent **speciesType**.

InSpeciesTypeBond also has an optional **name** attribute, of type **string**.

3.14.2 The bindingSite1 and bindingSite2 attributes

InSpeciesTypeBond has two required attributes, **bindingSite1** and **bindingSite2**, both of type **SIdRef**, used to reference a pair of binding sites of the **InSpeciesTypeBond** object in a **speciesType**. The referenced identifiers of the binding sites can be the **ids** of the **speciesTypeInstances** (binding sites), or the **ids** of the **speciesTypeComponentIndexes** indexing the binding sites and the ultimately referenced components must be the **BindingSiteSpeciesType** objects. Obviously, **bindingSite1** and **bindingSite2** must not reference the same **BindingSiteSpeciesType** object.

3.15 Uniqueness of **SpeciesType** definitions

In some special cases, it may be possible to define a **speciesType** in multiple equivalent ways.

Figure 8 shows an example of a **speciesType** constructed in two different formats. The two “**st_x**” **speciesTypes** in the diagram can be the results of different reaction paths, but they are equivalent and define the same **speciesType**.

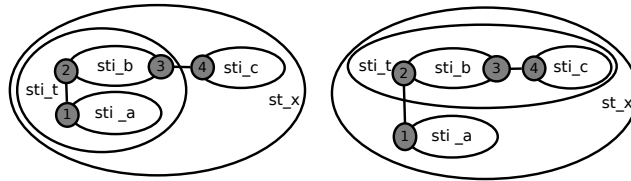

Figure 8: Different formats of the same **speciesType**

Construct 1: The definition of **speciesType** “**st_x**” on the left in Figure 8.

```

<multi:listOfSpeciesTypes>
  <multi:bindingSiteSpeciesType multi:id="st1" />
  <multi:bindingSiteSpeciesType multi:id="st2" />
  <multi:bindingSiteSpeciesType multi:id="st3" />
  <multi:bindingSiteSpeciesType multi:id="st4" />
  <multi:speciesType multi:id="st_a">
    <multi:listOfSpeciesTypeInstances>
      <multi:speciesTypeInstance multi:id="_1" multi:speciesType="st1" multi:occur="1" />
    </multi:listOfSpeciesTypeInstances>
  </multi:speciesType>
  <multi:speciesType multi:id="st_b">
    <multi:listOfSpeciesTypeInstances>
      <multi:speciesTypeInstance multi:id="_2" multi:speciesType="st2" multi:occur="1" />
      <multi:speciesTypeInstance multi:id="_3" multi:speciesType="st3" multi:occur="1" />
    </multi:listOfSpeciesTypeInstances>
  </multi:speciesType>
  <multi:speciesType multi:id="st_c">
    <multi:listOfSpeciesTypeInstances>
      <multi:speciesTypeInstance multi:id="_4" multi:speciesType="st4" multi:occur="1" />
    </multi:listOfSpeciesTypeInstances>
  </multi:speciesType>
  <multi:speciesType multi:id="st_t">
    <multi:listOfSpeciesTypeInstances>
      <multi:speciesTypeInstance multi:id="sti_a" multi:speciesType="st_a" multi:occur="1" />
      <multi:speciesTypeInstance multi:id="sti_b" multi:speciesType="st_b" multi:occur="1" />
    </multi:listOfSpeciesTypeInstances>
    <multi:listOfInSpeciesTypeBonds>
      <multi:inSpeciesTypeBond multi:bindingSite1="_1" multi:bindingSite2="_2" />
    </multi:listOfInSpeciesTypeBonds>
  </multi:speciesType>
  <multi:speciesType multi:id="st_x">
    <multi:listOfSpeciesTypeInstances>
      <multi:speciesTypeInstance multi:id="sti_t" multi:speciesType="st_t" multi:occur="1" />
      <multi:speciesTypeInstance multi:id="sti_c" multi:speciesType="st_c" multi:occur="1" />
    </multi:listOfSpeciesTypeInstances>
    <multi:listOfInSpeciesTypeBonds>
      <multi:inSpeciesTypeBond multi:bindingSite1="_3" multi:bindingSite2="_4" />
    </multi:listOfInSpeciesTypeBonds>
  </multi:speciesType>
</multi:listOfSpeciesTypes>

```

Construct 2: The definition of speciesType “st_x” on the right in [Figure 8 on the preceding page](#).

```

<multi:listOfSpeciesTypes>
  <multi:bindingSiteSpeciesType multi:id="st1" />
  <multi:bindingSiteSpeciesType multi:id="st2" />
  <multi:bindingSiteSpeciesType multi:id="st3" />
  <multi:bindingSiteSpeciesType multi:id="st4" />
  <multi:speciesType multi:id="st_a">
    <multi:listOfSpeciesTypeInstances>
      <multi:speciesTypeInstance multi:id="_1" multi:speciesType="st1" multi:occur="1" />
    </multi:listOfSpeciesTypeInstances>
  </multi:speciesType>
  <multi:speciesType multi:id="st_b">
    <multi:listOfSpeciesTypeInstances>
      <multi:speciesTypeInstance multi:id="_2" multi:speciesType="st2" multi:occur="1" />
      <multi:speciesTypeInstance multi:id="_3" multi:speciesType="st3" multi:occur="1" />
    </multi:listOfSpeciesTypeInstances>
  </multi:speciesType>
  <multi:speciesType multi:id="st_c">
    <multi:listOfSpeciesTypeInstances>
      <multi:speciesTypeInstance multi:id="_4" multi:speciesType="st4" multi:occur="1" />
    </multi:listOfSpeciesTypeInstances>
  </multi:speciesType>
  <multi:speciesType multi:id="st_t">
    <multi:listOfSpeciesTypeInstances>
      <multi:speciesTypeInstance multi:id="sti_b" multi:speciesType="st_b" multi:occur="1" />
      <multi:speciesTypeInstance multi:id="sti_c" multi:speciesType="st_c" multi:occur="1" />
    </multi:listOfSpeciesTypeInstances>
    <multi:listOfInSpeciesTypeBonds>
      <multi:inSpeciesTypeBond multi:bindingSite1="_3" multi:bindingSite2="_4" />
    </multi:listOfInSpeciesTypeBonds>
  </multi:speciesType>
  <multi:speciesType multi:id="st_x">
    <multi:listOfSpeciesTypeInstances>
      <multi:speciesTypeInstance multi:id="sti_a" multi:speciesType="st_a" multi:occur="1" />
      <multi:speciesTypeInstance multi:id="sti_t" multi:speciesType="st_t" multi:occur="1" />
    </multi:listOfSpeciesTypeInstances>
    <multi:listOfInSpeciesTypeBonds>
      <multi:inSpeciesTypeBond multi:bindingSite1="_1" multi:bindingSite2="_2" />
    </multi:listOfInSpeciesTypeBonds>
  </multi:speciesType>
</multi:listOfSpeciesTypes>

```

This kind of ambiguity cannot be avoided for **speciesTypes** involving more than two subcomponents connected by **inSpeciesTypeBonds**, for example, the **speciesType** referenced by the product **species** in an association reaction. It is up to the modeler (parser) to identify whether the two **speciesTypes** such as those in the example above are identical.

3.16 Species

A **species** in SBML Level 3 Core refers a pool of entities. A **species** in the Multi package is extended from a pool to a template or pattern which multiple pools may map to. An extended **species** can reference a **speciesType** that provides the backbone for the **species** such as **components** (including **binding sites**) and **speciesFeatureTypes**. When referencing a **speciesType**, a **species** can be further defined with regard to the binding statuses of its **outwardBindingSites** and the **speciesFeatures**. With the options to have variable values selected, such as “either” for the **bindingStatus** attribute and multiple possible **speciesFeatureValues** for a **speciesFeature**, an extended **species** can work as a template or pattern how **species** participate in **reactions**.

The extension of the **Species** class is illustrated in Figure 9. The extended **Species** class has a new optional attribute **speciesType**, and two extra optional **ListOfOutwardBindingSites** and **ListOfSpeciesFeatures** children. A **species** may have a **listOfOutwardBindingSites** child and/or a **listOfSpeciesFeatures** child only when its **speciesType** attribute has been defined.

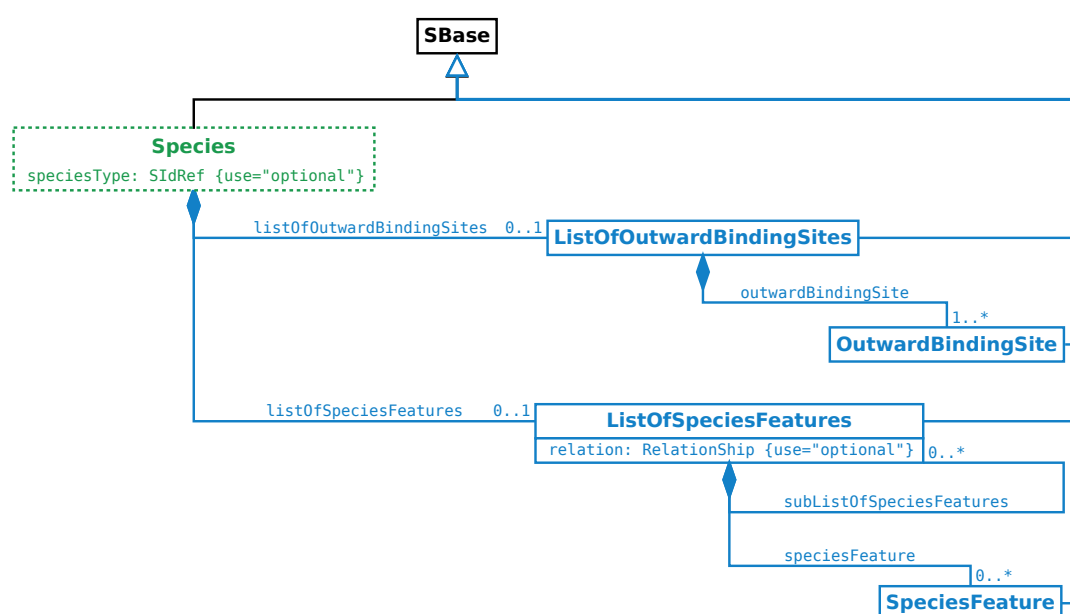

Figure 9: The extension of the **Species** class

3.16.1 The speciesType attribute

The optional attribute **speciesType**, of type **SIdRef**, references a **SpeciesType** object.

3.16.2 ListOfOutwardBindingSites

ListOfOutwardBindingSites is defined in Figure 9, and can only be defined when the **speciesType** attribute is defined. If present, it must have one or more **OutwardBindingSite** children. Since **ListOfOutwardBindingSites** is derived from **SBase**, it inherits the **sboTerm** and **metaid** attributes, as well as the optional children **Notes** and **Annotation** objects.

Note:

The **listOfOutwardBindingSites** of a **species** is not necessary to list all the **outwardBindingSites** (the **binding sites** not involved in any **inSpeciesTypeBond**) defined by the referenced **speciesType**. If an **outwardBindingSite** is not listed in the **listOfOutwardBindingSites**, the value of its **bindingStatus** is “either”, in other words, the **binding site** is in a “don’t care” state.

3.16.3 ListOfSpeciesFeatures

ListOfSpeciesFeatures is defined in [Figure 9 on the previous page](#), and can only be defined when the **speciesType** attribute is defined. If present, it must have one or more children. A child can be a **SpeciesFeature** object, or a **subListOfSpeciesFeatures**, which is a **ListOfSpeciesFeatures** object.

ListOfSpeciesFeatures has an optional attribute **relation**, of type **Relation**, to define the logic relationship among its children. The **relation** attribute can not be defined if a **listOfSpeciesFeatures** has only one child, and it must be defined if the **listOfSpeciesFeatures** has more than one children.

 *Note:*

*The **listOfSpeciesFeatures** of a species does not have to cover all the **speciesFeatures** corresponding to all **speciesFeatureTypes** (see [Section 3.9 on page 14](#)) of every component defined by the referenced **speciesType**. If a **speciesFeatureType** is defined and there is no **speciesFeature** explicitly referencing it, the species has an implicit **speciesFeature** having all the **listOfPossibleSpeciesFeatureValues** and “or” relationships between them. In other words, the implicit **speciesFeature** has a “don’t care” state for the species.*

Since **ListOfSpeciesFeatures** is derived from **SBase**, it inherits the **sboTerm** and **metaid** attributes, as well as the optional children **Notes** and **Annotation** objects.

The example at [Section 3.18.7 on page 30](#) illustrates the usage of the **ListOfSpeciesFeatures** class.

3.17 OutwardBindingSite

OutwardBindingSite is defined in Figure 10. It has two required attributes, **bindingStatus** and **component**. A binding site not involved in any **InSpeciesTypeBond** object in the **speciesType** referenced by a **species** is an **outwardBindingSite**. Since **OutwardBindingSite** is derived from **SBase**, it inherits the **sboTerm** and **metaid** attributes, as well as the optional children **Notes** and **Annotation** objects.

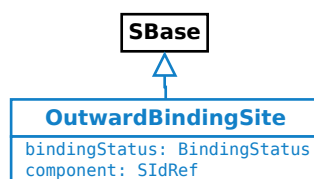

Figure 10: The definition of the **OutwardBindingSite** class

3.17.1 The bindingStatus attribute

The **bindingStatus** attribute takes a value of type **BindingStatus**.

3.17.2 The component attribute

The **component** attribute, of type **SIdRef**, references a **component** which ultimately reference a **BindingSiteSpeciesType** object. The attribute value must be the identifier of a **SpeciesTypeInstance**, **SpeciesTypeComponentIndex** or **SpeciesType** object.

3.17.3 Example

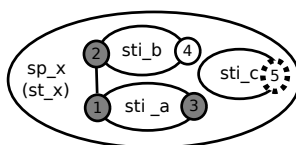

Figure 11: An example of **OutwardBindingSite**

Figure 11 illustrates the usage of the **OutwardBindingSite** class. Species “**sp_x**” references speciesType “**st_x**”, which has three speciesTypeInstances “**sti_a**”, “**sti_b**” and “**sti_c**”. SpeciesTypeInstance “**sti_a**” has bindingSites “**_1**” and “**_3**”, speciesTypeInstance “**sti_b**” has bindingSites “**_2**” and “**_4**”, and speciesTypeInstance “**sti_c**” has bindingSite “**_5**”. The **inSpeciesTypeBond** in “**st_x**” involves two bindingSites “**_1**” and “**_2**”. The other three bindingSites, “**_3**”, “**_4**” and “**_5**”, in the species “**sp_x**” are **outwardBindingSites**. The outwardBindingSite “**_3**” is “**bound**” (filled circle with solid line in the diagram), the outwardBindingSite “**_4**” is “**unbound**” (empty circle with solid line) and the outwardBindingSite “**_5**” has binding status “**either**” (empty circle with dotted line). The corresponding SBML code would be as follows:

```

<multi:listOfSpeciesTypes>
  <multi:bindingSiteSpeciesType multi:id="st_1" />
  <multi:bindingSiteSpeciesType multi:id="st_2" />
  <multi:bindingSiteSpeciesType multi:id="st_3" />
  <multi:bindingSiteSpeciesType multi:id="st_4" />
  <multi:bindingSiteSpeciesType multi:id="st_5" />
  <multi:speciesType multi:id="st_a">
    <multi:listOfSpeciesTypeInstances>
      <multi:speciesTypeInstance multi:id="_1" multi:speciesType="st_1" multi:occur="1" />
      <multi:speciesTypeInstance multi:id="_3" multi:speciesType="st_3" multi:occur="1" />
    
```

```

</multi:listOfSpeciesTypeInstances>
</multi:speciesType>
<multi:speciesType multi:id="st_b">
  <multi:listOfSpeciesTypeInstances>
    <multi:speciesTypeInstance multi:id="_2" multi:speciesType="st_2" multi:occur="1" />
    <multi:speciesTypeInstance multi:id="_4" multi:speciesType="st_4" multi:occur="1" />
  </multi:listOfSpeciesTypeInstances>
</multi:speciesType>
<multi:speciesType multi:id="st_c">
  <multi:listOfSpeciesTypeInstances>
    <multi:speciesTypeInstance multi:id="_5" multi:speciesType="st_5" multi:occur="1" />
  </multi:listOfSpeciesTypeInstances>
</multi:speciesType>
<multi:speciesType multi:id="st_x">
  <multi:listOfSpeciesTypeInstances>
    <multi:speciesTypeInstance multi:id="sti_a" multi:speciesType="st_a" multi:occur="1" />
    <multi:speciesTypeInstance multi:id="sti_b" multi:speciesType="st_b" multi:occur="1" />
    <multi:speciesTypeInstance multi:id="sti_c" multi:speciesType="st_c" multi:occur="1" />
  </multi:listOfSpeciesTypeInstances>
  <multi:listOfInSpeciesTypeBonds>
    <multi:inSpeciesTypeBond multi:bindingSite1="_1" multi:bindingSite2="_2" />
  </multi:listOfInSpeciesTypeBonds>
</multi:speciesType>
</multi:listOfSpeciesTypes>
<listOfSpecies>
  <species id="sp_x" multi:speciesType="st_x">
    <multi:listOfOutwardBindingSites>
      <multi:outwardBindingSite multi:component="_3" multi:bindingStatus="bound" />
      <multi:outwardBindingSite multi:component="_4" multi:bindingStatus="unbound" />
      <multi:outwardBindingSite multi:component="_5" multi:bindingStatus="either" />
    </multi:listOfOutwardBindingSites>
  </species>
</listOfSpecies>

```

6
7
8
9
10
11
12
13
14
15
16
17
18
19
20
21
22
23
24
25
26
27
28
29
30
31
32
33
34
1
2
3
4
5

3.18 SpeciesFeature

SpeciesFeature is defined in Figure 12. It has two optional attributes, `id` and `component`, two required attributes, `speciesFeatureType` and `occur`, and a required child `listOfSpeciesFeatureValues`. Since **SpeciesFeature** is derived from **SBase**, it inherits the `sboTerm` and `metaid` attributes, as well as the optional children **Notes** and **Annotation** objects. **SpeciesFeature** serves to define the state of a component in a species by selecting values from the `listOfPossibleSpeciesFeatureValues` of the referenced `speciesFeatureType`.

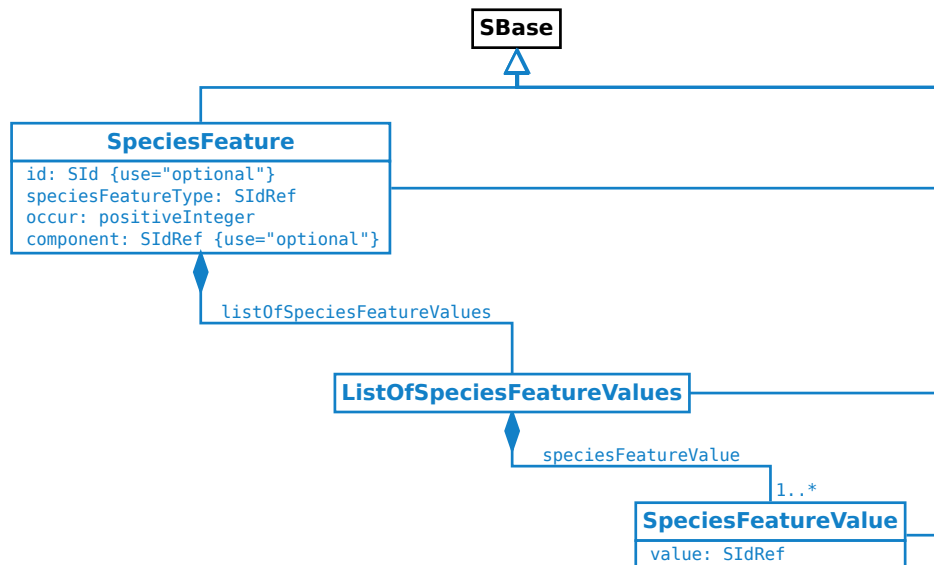

Figure 12: The definitions of the **SpeciesFeature** class and the **SpeciesFeatureValue** class

3.18.1 The id attribute

The optional `id` attribute, of type `SId`, can serve to provide a way to identify a `speciesFeature`. If present, the value must be unique within the species.

3.18.2 The speciesFeatureType attribute

SpeciesFeature has a required attribute `speciesFeatureType`, of type `SIdRef`, used to reference a `speciesFeatureType`.

3.18.3 The occur attribute

SpeciesFeature has a required attribute `occur`, of type of `positiveInteger`, used to define the number of instances of the referenced `speciesFeatureType`.

The value of the `occur` attribute can not be larger than the `occur` of the referenced `speciesFeatureType`. When a `speciesFeatureType` has multiple instances (`speciesFeatureType`'s `occur` > "1"), the `speciesFeature`'s `occur` attribute provides a way for a species to define the instances of the `speciesFeatureType` differently.

For example, in a `speciesType`, `speciesFeatureType` "ftA" has `occur`="2" and two possible `SpeciesFeatureValues` "fva1" and "fva2". A species referencing the `speciesType` can be defined to have two `speciesFeatures` "sfA1" and "sfA2" both referencing "ftA". The `speciesFeature` "sfA1" has `occur`="1" and its value is "fva1". The `speciesFeature` "sfA2" has `occur`="1" and its value is "fva2".

If the `occur` of a `speciesFeature` is less than the `occur` of the referenced `speciesFeatureType`, the rest of the unspecified instances of the `speciesFeatureType` are in "don't care" state which means that the value of an unspecified instance can be any from the `listOfPossibleSpeciesFeatureValues`.

For example, in a `speciesType`, a `speciesFeatureType` “phosphorylation” has two possible `SpeciesFeatureValues` “phosphorylated” and “unphosphorylated” and the `occur` is “5”. A `species` referencing the `speciesType` can be defined to have a `speciesFeature` of the “phosphorylation” with the value of “phosphorylated” and the `occur` of “1”. Then, the `species` is a pattern `species` with at least one “phosphorylated” site (the other four “phosphorylation” sites are in “don’t care” state). (See the example in [Section 3.25.4 on page 42.](#)) This pattern `species` can be mapped by anyone of the “fully defined” `species` (see [Section 3.19 on page 34](#)) of the same type and with any of “1” to “5” phosphorylated sites.

3.18.4 The component attribute

The optional `component` attribute, of type `SIRef`, can be used to indicate which **component** of a `species` the `speciesFeature` belongs to. It is required when the `component` can not be identified only based on the `speciesFeatureType` attribute.

3.18.5 ListOfSpeciesFeatureValues

`ListOfSpeciesFeatureValues` is defined in [Figure 12 on the previous page](#), and must have one or more `SpeciesFeatureValue` children. If a `ListOfSpeciesFeatures` has multiple `speciesFeatureValues`, the interpretation of the relationship between them is “or”. Since `ListOfSpeciesFeatureValues` is derived from `SBase`, it inherits the `sboTerm` and `metaid` attributes, as well as the optional children `Notes` and `Annotation` objects.

3.18.6 SpeciesFeatureValue

`SpeciesFeatureValue` is defined in [Figure 12 on the preceding page](#). A `speciesFeatureValue` serves to specify a value for a `speciesFeature` to select from the `listOfPossibleSpeciesFeatureValues` defined in the referenced `speciesFeatureType`. The `SpeciesFeatureValue` class has only one attribute value of type `SIRef`, used to reference a `PossibleSpeciesFeatureValue` object. Since `SpeciesFeatureValue` is derived from `SBase`, it inherits the `sboTerm` and `metaid` attributes, as well as the optional children `Notes` and `Annotation` objects.

3.18.7 Example

[Figure 13 on the next page](#) is an example `speciesType` to illustrate the usage of the `ListOfSpeciesFeatures` and `SpeciesFeature` classes. `SpeciesType` “`st_A`” has a `speciesFeatureType` “`fa`” which has two possible `SpeciesFeatureValues` “`fa1`” and “`fa2`”. The `speciesType` “`st_A`” also has two children `speciesTypeInstances` “`sti_B`” and “`sti_C`”, which have `speciesFeatureTypes` “`fb`” and “`fc`” respectively. The `speciesFeatureType` “`fb`” has possible `SpeciesFeatureValues` “`fb1`” and “`fb2`”, and the `speciesFeatureType` “`fc`” has “`fc1`” and “`fc2`”. Here are several ways to construct the `listOfSpeciesFeatures` of a `species` referencing the `speciesType` “`st_A`”:

- `listOfSpeciesFeatures` (relation=“and”, children=“`fa1`”, “`fb1`”, “`fc1`”) is a state:
“`[fa1] and [fb1] and [fc1]`”
- `listOfSpeciesFeatures` (relation=“or”, children=
 `subListOfSpeciesFeatures` (relation=“and”, children=“`fa1`”, “`fb1`”, “`fc1`”),
 `subListOfSpeciesFeatures` (relation=“and”, children=“`fa2`”, “`fb2`”, “`fc2`”)
) is a state:
“`[fa1] and [fb1] and [fc1]`” or “`[fa2] and [fb2] and [fc2]`”
- `listOfSpeciesFeatures` (relation=“and”, children=
 “`fa1`”,
 `subListOfSpeciesFeatures` (relation=“not”, children=“`fb1`”, “`fc1`”)
) is a state:
“`[fa1] and [fb1] and [fc2]`” or “`[fa1] and [fb2] and [fc2]`” or “`[fa1] and [fb2] and [fc1]`”

The SBML code can be as follows and the `species` “`sp_A1`”, “`sp_A2`” and “`sp_A3`” contain the tree `listOfSpeciesFeatures` above respectively.

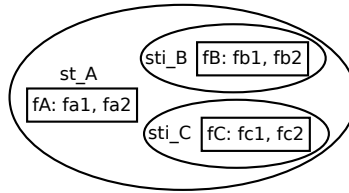

Figure 13: An example speciesFeatureType to illustrate the usage of the [ListOfSpeciesFeatures](#) class and the [SpeciesFeature](#) class

```

<multi:listOfSpeciesTypes>
  <multi:bindingSiteSpeciesType multi:id="st_B">
    <multi:listOfSpeciesFeatureTypes>
      <multi:speciesFeatureType multi:id="fB" multi:occur="1">
        <multi:listOfPossibleSpeciesFeatureValues>
          <multi:possibleSpeciesFeatureValue multi:id="fb1" />
          <multi:possibleSpeciesFeatureValue multi:id="fb2" />
        </multi:listOfPossibleSpeciesFeatureValues>
      </multi:speciesFeatureType>
    </multi:listOfSpeciesFeatureTypes>
  </multi:bindingSiteSpeciesType>
  <multi:bindingSiteSpeciesType multi:id="st_C">
    <multi:listOfSpeciesFeatureTypes>
      <multi:speciesFeatureType multi:id="fC" multi:occur="1">
        <multi:listOfPossibleSpeciesFeatureValues>
          <multi:possibleSpeciesFeatureValue multi:id="fc1" />
          <multi:possibleSpeciesFeatureValue multi:id="fc2" />
        </multi:listOfPossibleSpeciesFeatureValues>
      </multi:speciesFeatureType>
    </multi:listOfSpeciesFeatureTypes>
  </multi:bindingSiteSpeciesType>
  <multi:speciesType multi:id="st_A">
    <multi:listOfSpeciesFeatureTypes>
      <multi:speciesFeatureType multi:id="fA" multi:occur="1">
        <multi:listOfPossibleSpeciesFeatureValues>
          <multi:possibleSpeciesFeatureValue multi:id="fa1" />
          <multi:possibleSpeciesFeatureValue multi:id="fa2" />
        </multi:listOfPossibleSpeciesFeatureValues>
      </multi:speciesFeatureType>
    </multi:listOfSpeciesFeatureTypes>
    <multi:listOfSpeciesTypeInstances>
      <multi:speciesTypeInstance multi:id="sti_B" multi:speciesType="st_B"
        multi:occur="1" />
      <multi:speciesTypeInstance multi:id="sti_C" multi:speciesType="st_C"
        multi:occur="1" />
    </multi:listOfSpeciesTypeInstances>
  </multi:speciesType>
</multi:listOfSpeciesTypes>
<listOfSpecies>
  <species id="sp_A1" multi:speciesType="st_A" .>
    <!-- [fa1] and [fb1] and [fc1] -->
    <multi:listOfSpeciesFeatures multi:relation="and">
      <multi:speciesFeature multi:speciesFeatureType="fA" multi:occur="1"
        multi:component="st_A">
        <multi:listOfSpeciesFeatureValues>
          <multi:speciesFeatureValue multi:value="fa1" />
        </multi:listOfSpeciesFeatureValues>
      </multi:speciesFeature>
      <multi:speciesFeature multi:speciesFeatureType="fB" multi:occur="1"
        multi:component="sti_B">
        <multi:listOfSpeciesFeatureValues>
          <multi:speciesFeatureValue multi:value="fb1" />
        </multi:listOfSpeciesFeatureValues>
    </multi:listOfSpeciesFeatures>
  </species>

```

6
7
8
9
10
11
12
13
14
15
16
17
18
19
20
21
22
23
24
25
26
27
28
29
30
31
32
33
34
35
36
37
38
39
40
41
42
43
44
45
46
47
48
49
50
51
52
53
54
1
2
3
4
5

```

</multi:speciesFeature>
<multi:speciesFeature multi:speciesFeatureType="fC" multi:occur="1"
  multi:component="sti_C">
  <multi:listOfSpeciesFeatureValues>
    <multi:speciesFeatureValue multi:value="fc1" />
  </multi:listOfSpeciesFeatureValues>
</multi:speciesFeature>
</multi:listOfSpeciesFeatures>
<multi:listOfOutwardBindingSites>
  ...
</multi:listOfOutwardBindingSites>
</species>
<species id="sp_A2" multi:speciesType="st_A" .>
  <!-- {[fa1] and [fb1]} and [fc1]} or {[fa2] and [fb2] and [fc2]} -->
  <multi:listOfSpeciesFeatures multi:relation="or">
    <multi:subListofSpeciesFeatures multi:relation="and">
      <multi:speciesFeature multi:speciesFeatureType="fA" multi:occur="1"
        multi:component="st_A">
        <multi:listOfSpeciesFeatureValues>
          <multi:speciesFeatureValue multi:value="fa1" />
        </multi:listOfSpeciesFeatureValues>
      </multi:speciesFeature>
      <multi:speciesFeature multi:speciesFeatureType="fB" multi:occur="1"
        multi:component="sti_B">
        <multi:listOfSpeciesFeatureValues>
          <multi:speciesFeatureValue multi:value="fb1" />
        </multi:listOfSpeciesFeatureValues>
      </multi:speciesFeature>
      <multi:speciesFeature multi:speciesFeatureType="fC" multi:occur="1"
        multi:component="sti_C">
        <multi:listOfSpeciesFeatureValues>
          <multi:speciesFeatureValue multi:value="fc1" />
        </multi:listOfSpeciesFeatureValues>
      </multi:speciesFeature>
    </multi:subListofSpeciesFeatures>
  </multi:listOfSpeciesFeatures multi:relation="and">
    <multi:speciesFeature multi:speciesFeatureType="fA" multi:occur="1"
      multi:component="st_A">
      <multi:listOfSpeciesFeatureValues>
        <multi:speciesFeatureValue multi:value="fa2" />
      </multi:listOfSpeciesFeatureValues>
    </multi:speciesFeature>
    <multi:speciesFeature multi:speciesFeatureType="fB" multi:occur="1"
      multi:component="sti_B">
      <multi:listOfSpeciesFeatureValues>
        <multi:speciesFeatureValue multi:value="fb2" />
      </multi:listOfSpeciesFeatureValues>
    </multi:speciesFeature>
    <multi:speciesFeature multi:speciesFeatureType="fC" multi:occur="1"
      multi:component="sti_C">
      <multi:listOfSpeciesFeatureValues>
        <multi:speciesFeatureValue multi:value="fc2" />
      </multi:listOfSpeciesFeatureValues>
    </multi:speciesFeature>
  </multi:subListofSpeciesFeatures>
</multi:listOfSpeciesFeatures>
<multi:listOfOutwardBindingSites>
  ...
</multi:listOfOutwardBindingSites>
</species>
<species id="sp_A3" multi:speciesType="st_A" .>
  <!-- {[fa1] and [fb1] and [fc2]} or {[fa1] and [fb2] and [fc2]} or {[fa1] and [fb2] and [fc1]} -->
  <multi:listOfSpeciesFeatures multi:relation="and">
    <multi:speciesFeature multi:speciesFeatureType="fA" multi:occur="1"
      multi:component="st_A">
      <multi:listOfSpeciesFeatureValues>

```

```

        <multi:speciesFeatureValue multi:value="fa1" />
    </multi:listOfSpeciesFeatureValues>
</multi:speciesFeature>
<multi:subListOfSpeciesFeatures multi:relation="not">

    <multi:speciesFeature multi:speciesFeatureType="fB" multi:occur="1"
        multi:component="sti_B">
        <multi:listOfSpeciesFeatureValues>
            <multi:speciesFeatureValue multi:value="fb1" />
        </multi:listOfSpeciesFeatureValues>
    </multi:speciesFeature>
    <multi:speciesFeature multi:speciesFeatureType="fC" multi:occur="1"
        multi:component="sti_C">
        <multi:listOfSpeciesFeatureValues>
            <multi:speciesFeatureValue multi:value="fc1" />
        </multi:listOfSpeciesFeatureValues>
    </multi:speciesFeature>
</multi:subListOfSpeciesFeatures>
</multi:listOfSpeciesFeatures>
<multi:listOfOutwardBindingSites>
    ...
</multi:listOfOutwardBindingSites>
</species>
</listOfSpecies>

```

6
7
8
9
10
11
12
13
14
15
16
17
18
19
20
21
22
23
24
25
1
2
3
4
5

3.19 “Fully defined” species and the mapping to “pattern” species

An extended **Species** object functions as a template or a pattern which allows multiple pools of entities to map to it. A species is “fully defined” if there is only one pool mapping to it. A “fully defined” species can be considered the same as a SBML core species, and can be initialized with the `initialAmount` attribute, or the `initialConcentration` attribute, or via an **InitialAssignment** object. In the Multi package, a species is “fully defined” if the following conditions are fulfilled.

- All `outwardBindingSites` must be free (`bindingStatus=“unbound”`), since “bound” sites imply that there is a non-specified binding partner.
- Each `speciesFeature` occurrence can only have one `speciesFeatureValue`, and every occurrences of every `speciesFeatureTypes` of every `components` of the referenced `speciesType` must be referenced by exactly one `speciesFeature` occurrence.
- If applicable, only “and” values are allowed for the `relation` attributes of the **ListOfSpeciesFeatures** objects.
- Only one single **SpeciesFeatureValue** object is allowed for any `speciesFeature`.
- The referenced `compartment` can not be a `compartment type`, which means the value of the `isType` attribute of the referenced `compartment` can only be “false”.

The mapping from a “fully defined” species to a “pattern” species is implicit and can be inferred from the structure of the species. For example, a `speciesType` “`stA`” has one `speciesFeatureType` with two possible `SpeciesFeatureValues` “`v1`” and “`v2`”. A species “`spA1`” references “`stA`” and has the `speciesFeature` with the value of “`v1`”. Another species “`spA`” also references “`stA`” and has no `speciesFeature` explicitly defined. Thus, the species “`spA1`” is a “fully defined” species and can map to the “pattern” species “`spA`” because species “`spA`” has an implicit `speciesFeature` which can take either value “`v1`” or value “`v2`” (see the note in [Section A on page 83](#)).

 Note:

Theoretically, using “not” and “or” can also result in a “fully defined” species. For example, a `speciesType` has two feature types “A” (“`a1`” and “`a2`” as possible values) and “B” (“`b1`” and “`b2`” as possible values). A “fully defined” species referencing the `speciesType` can be defined to have a feature of “[`a1 and b1`]”. Equivalently, the species can also be defined to have “[not ([`a1 and b2`] or [`a2 and b2`] or [`a2 and b1`])]”. In the Multi package, the main reason to define “fully defined” species is to initialize species in a model. Therefore, the definition for “fully defined” species simply disallows “not” and “or” to make it easier for a modeler to define “fully defined” species.

3.20 Reaction

Reaction itself in the Multi package is not extended, but it may use the Multi **Species** objects to construct reactions. The **Reaction** class in the Multi package can not only define the relations among pools (SBML core **species**), but also the relations among patterns (Multi extended **species**). Several related classes including **SimpleSpeciesReference** and **SpeciesReference** are extended to handle some issues specific to the Multi package. A new class, **IntraSpeciesReaction**, is derived from **Reaction** to explicitly define those reactions within the same **Species** object. The changes under the **Reaction** class in the Multi package are illustrated in Figure 14.

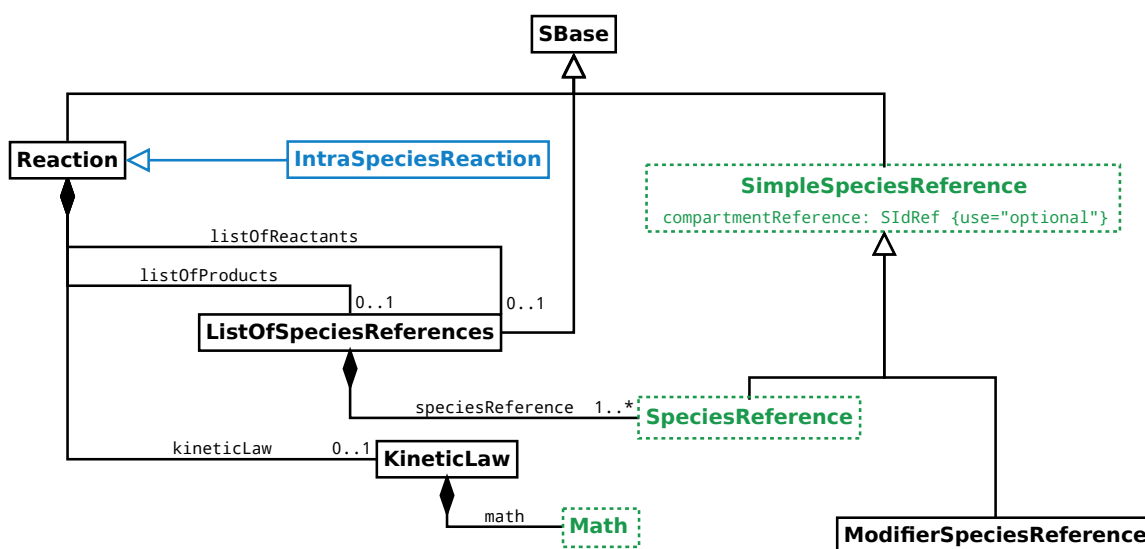

Figure 14: The changes under the **Reaction** class including **IntraSpeciesReaction**, **SimpleSpeciesReference**, **SpeciesReference** and **Math**

3.21 IntraSpeciesReaction

IntraSpeciesReaction is derived from **Reaction** for the reactions happening within a species (a binding reaction that links two binding sites within one complex would be an example).

A particular reaction may happen within a species as an **intraSpeciesReaction** if the following conditions are fulfilled.

- The reaction is either an association reaction or a dissociation reaction.
- If it is an association reaction, each of the two reactant species has at least one outwardBindingSite free (“unbound”).
- If it is a dissociation reaction, each of the two product species has at least one outwardBindingSite free (“unbound”).

Note:

Technically, transformations are also reactions happening with one species, but they do not have the ambiguity of association and dissociation reactions. Therefore, transformation reactions do not have to be defined as **intraSpeciesReactions**.

3.22 Extended SimpleSpeciesReference

The `SimpleSpeciesReference` class is extended with a new optional attribute `compartmentReference`, of type `SIIdRef`, to reference a `compartmentReference`. The `compartmentReference` attribute can serve to indicate which sub-compartment where an object of a class (`SpeciesReference` or `ModifierSpeciesReference`) inheriting `SimpleSpeciesReference` is located.

This example illustrates the use of the `compartmentReference` attribute. A model has a compartment type “c” and a composite compartment type “cc” with two `compartmentReferences` “cr1” and “cr2” both referencing the “c” compartment type. Both species “spA” and “spM” reference the “c” compartment type. A reaction happens between two “spA” species from the two compartments respectively and results in a cross-compartment product. One condition for this reaction is that two “spM” species work as modifiers in the two “c” compartments respectively. The situation described here could correspond to interactions among species located on two adjacent membranes. Without the `compartmentReference` attribute in the `SimpleSpeciesReference` class, it is impossible to distinguish the two “spA” species as well as the two “spM” species. The SBML code can be as follows:

```

<listOfCompartments>
  <compartment id="c" constant="true" multi:isType="true" />
  <compartment id="cc" constant="true" multi:isType="true">
    <multi:listOfCompartmentReferences>
      <multi:compartmentReference multi:id="cr1" multi:compartment="c" />
      <multi:compartmentReference multi:id="cr2" multi:compartment="c" />
    </multi:listOfCompartmentReferences>
  </compartment>
</listOfCompartments>
<multi:listOfSpeciesTypes>
  <multi:bindingSiteSpeciesType multi:id="stA" multi:compartment="c" />
  <multi:speciesType multi:id="stM" multi:compartment="c" />
  <multi:speciesType multi:id="stAA" multi:compartment="cc">
    <multi:listOfSpeciesTypeInstances>
      <multi:speciesTypeInstance multi:id="stiA1" multi:speciesType="stA"
        multi:compartmentReference="cr1" multi:occur="1" />
      <multi:speciesTypeInstance multi:id="stiA2" multi:speciesType="stA"
        multi:compartmentReference="cr2" multi:occur="1" />
    </multi:listOfSpeciesTypeInstances>
    <multi:listOfInSpeciesTypeBonds>
      <multi:inSpeciesTypeBond multi:bindingSite1="stiA1" multi:bindingSite2="stiA2" />
    </multi:listOfInSpeciesTypeBonds>
  </multi:speciesType>
</multi:listOfSpeciesTypes>
<listOfSpecies>
  <species id="spA" multi:speciesType="stA" compartment="c" ... />
  <species id="spM" multi:speciesType="stM" compartment="c" ... />
  <species id="spAA" multi:speciesType="stAA" compartment="cc" ... />
</listOfSpecies>
<reaction id="reaction" ...>
  <listOfReactants>
    <speciesReference id="r1" species="spA" multi:compartmentReference="cr1" ... />
    <speciesReference id="r2" species="spA" multi:compartmentReference="cr2" ... />
  </listOfReactants>
  <listOfProducts>
    <speciesReference species="spAA" ... />
  </listOfProducts>
  <listOfModifiers>
    <modifierSpeciesReference id="m1" species="spM" multi:compartmentReference="cr1" />
    <modifierSpeciesReference id="m2" species="spM" multi:compartmentReference="cr2" />
  </listOfModifiers>
  ...
</reaction>

```

3.23 Extended SpeciesReference

The **SpeciesReference** class is extended from SBML Level 3 Core and can establish **component** mappings between the reactant **species** and the product **species** when the mappings can not be inferred from the **ids** of the **SpeciesTypeInstance** objects. The **SpeciesReference** class has an optional **ListOfSpeciesTypeComponentMapsInProduct** child, as defined in Figure 15. Only a reaction product can contain the **ListOfSpeciesTypeComponentMapsInProduct** child and it is not necessary to store the mappings again in the reactants.

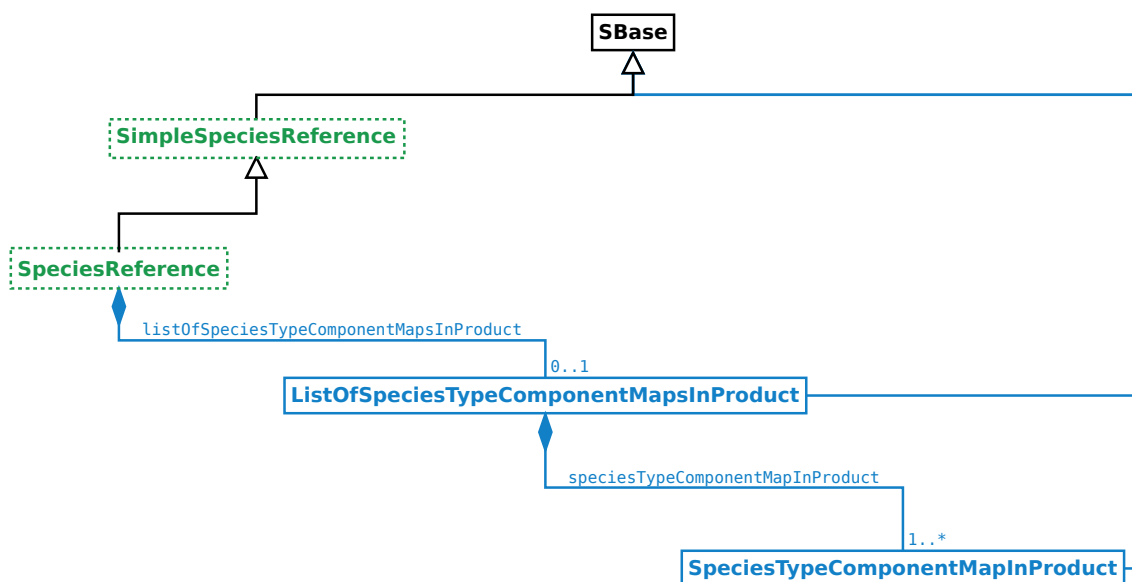

Figure 15: The extension of the **SpeciesReference** class

3.23.1 ListOfSpeciesTypeComponentMapsInProduct

ListOfSpeciesTypeComponentMapsInProduct is defined in Figure 15. If present, it must have one or more **SpeciesTypeComponentMapInProduct** children. Since **ListOfSpeciesTypeComponentMapsInProduct** is derived from **SBase**, it inherits the **sboTerm** and **metaid** attributes, as well as the optional children **Notes** and **Annotation** objects.

3.24 SpeciesTypeComponentMapInProduct

SpeciesTypeComponentMapInProduct is defined in Figure 16. Since **SpeciesTypeComponentMapInProduct** is derived from **SBase**, it inherits the `sboTerm` and `metaid` attributes, as well as the optional children **Notes** and **Annotation** objects.

A `speciesTypeComponentMapInProduct` defines the mapping between a **component** in a reactant and a **component** in a product. The identifications of a **component** and the `speciesReference` should be sufficient to identify the **component** in the context of a reaction. The attributes `reactant` and `reactantComponent` can identify the **component** in a reactant, and the `productComponent` attribute and the product storing the mapping information can identify the **component** in a product.

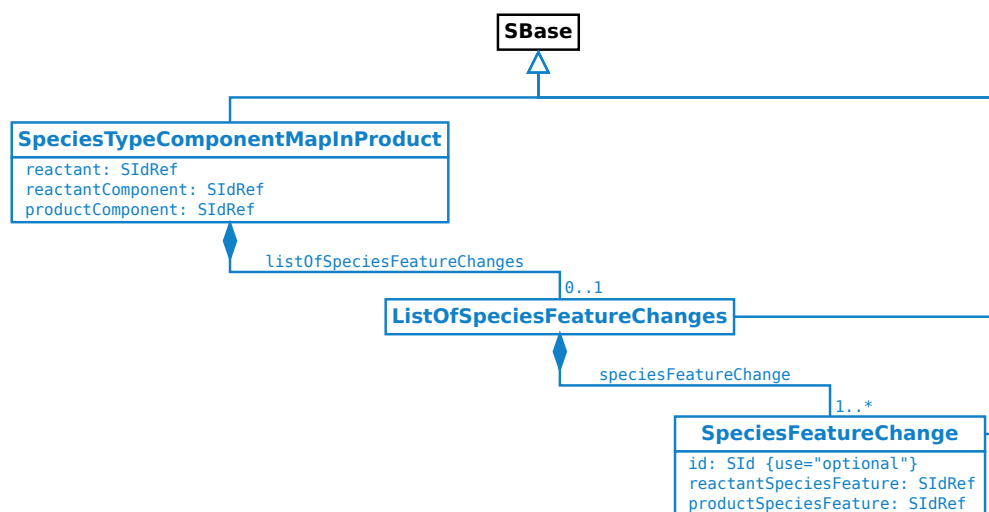

Figure 16: The definitions of the `SpeciesTypeComponentMapInProduct` and `SpeciesFeatureChange` classes

3.24.1 The reactant attribute

SpeciesTypeComponentMapInProduct has a required `reactant` attribute, of type `SIdRef`, to reference the `id` of a reactant `speciesReference` in a reaction.

3.24.2 The reactantComponent attribute

SpeciesTypeComponentMapInProduct has a required `reactantComponent` attribute, of type `SIdRef`, to reference a **component** in a reactant species.

3.24.3 The productComponent attribute

SpeciesTypeComponentMapInProduct has a required `productComponent` attribute, of type `SIdRef`, to reference a **component** in a product species.

3.24.4 ListOfSpeciesFeatureChanges

SpeciesTypeComponentMapInProduct also has an optional `ListOfSpeciesFeatureChanges` child to explicitly define changes of `speciesFeatures` in a reaction. If present, it must have one or more `SpeciesFeatureChange` children. Since `ListOfSpeciesFeatureChanges` is derived from **SBase**, it inherits the `sboTerm` and `metaid` attributes, as well as the optional children **Notes** and **Annotation** objects.

3.24.5 Example

Figure 17 illustrates the use of the `SpeciesTypeComponentMapInProduct` class. SpeciesType “stX” has two “b” bindingSites and one “A” speciesFeatureType that has a listOfPossibleSpeciesFeatureValues “a1” and “a2”. The “spY” species has two speciesTypeInstances “stiX1” and “stiX2” both referencing the “stX” speciesType. The “spX” species references the “stX” speciesType. The reaction is an association between one bindingSite “b” of “stiX2” in “spY” and another bindingSite “b” in “spX”.

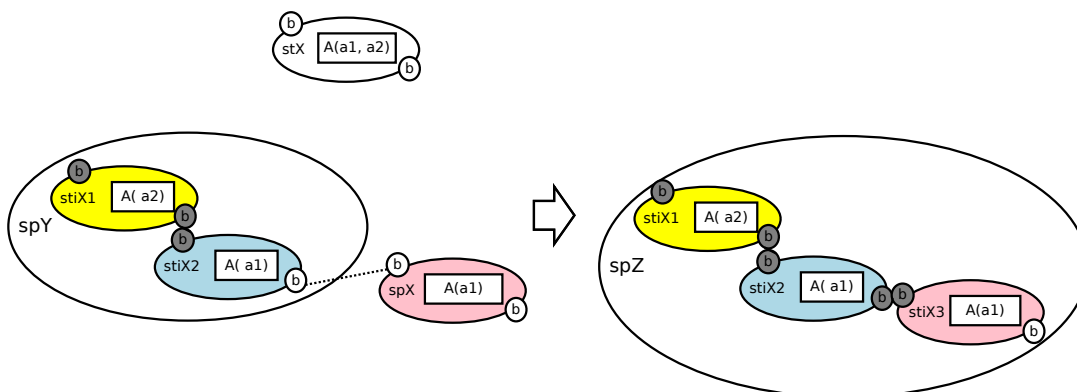

Figure 17: An example illustrating the usage of the `SpeciesTypeComponentMapInProduct` class (colors for mappings)

The mappings are as follows and indicated by the colors in the diagram:

- “stiX1” of “spY” <==> “stiX1” of “spZ”.
- “stiX2” of “spY” <==> “stiX2” of “spZ”.
- “spX” <==> “stiX3” of “spZ”.

The SBML code can be as follows:

```
<multi:listOfSpeciesTypes>
  <multi:bindingSiteSpeciesType multi:id="stB" />
  <multi:speciesType multi:id="stX">
    <multi:listOfSpeciesTypeInstances>
      <multi:speciesTypeInstance multi:id="b" multi:speciesType="stB" multi:occur="2" />
    </multi:listOfSpeciesTypeInstances>
    <multi:listOfSpeciesFeatureTypes>
      <multi:speciesFeatureType multi:id="A">
        <multi:listOfPossibleSpeciesFeatureValues>
          <multi:possibleSpeciesFeatureValue multi:id="a1" />
          <multi:possibleSpeciesFeatureValue multi:id="a2" />
        </multi:listOfPossibleSpeciesFeatureValues>
      </multi:speciesFeatureType>
    </multi:listOfSpeciesFeatureTypes>
    <multi:listOfSpeciesTypeComponentIndexes>
      <multi:speciesTypeComponentIndex multi:id="b1" multi:component="b"
        multi:occur="1" />
      <multi:speciesTypeComponentIndex multi:id="b2" multi:component="b"
        multi:occur="1"/>
    </multi:listOfSpeciesTypeComponentIndexes>
  </multi:speciesType>
  <multi:speciesType multi:id="stY">
```



```

<multi:listOfSpeciesTypeInstances>
  <multi:speciesTypeInstance multi:id="stiX1" multi:speciesType="stX" multi:occur="1" />
  <multi:speciesTypeInstance multi:id="stiX2" multi:speciesType="stX" multi:occur="1" />
</multi:listOfSpeciesTypeInstances>
<multi:listOfSpeciesTypeComponentIndexes>
  <multi:speciesTypeComponentIndex multi:id="x1b1" multi:component="b"
    mult:identifyingParent="stiX1" multi:occur="1" />
  <multi:speciesTypeComponentIndex multi:id="x1b2" multi:component="b"
    mult:identifyingParent="stiX1" multi:occur="1" />
  <multi:speciesTypeComponentIndex multi:id="x2b1" multi:component="b"
    mult:identifyingParent="stiX2" multi:occur="1" />
  <multi:speciesTypeComponentIndex multi:id="x2b2" multi:component="b"
    mult:identifyingParent="stiX2" multi:occur="1" />
</multi:listOfSpeciesTypeComponentIndexes>
<multi:listOfInSpeciesTypeBonds>
  <multi:inSpeciesTypeBond multi:bindingSite1="x1b2" multi:bindingSite2="x2b1" />
</multi:listOfInSpeciesTypeBonds>
</multi:speciesType>
<multi:speciesType multi:id="stZ">
  <multi:listOfSpeciesTypeInstances>
    <multi:speciesTypeInstance multi:id="stiX1" multi:speciesType="stX" multi:occur="1" />
    <multi:speciesTypeInstance multi:id="stiX2" multi:speciesType="stX" multi:occur="1" />
    <multi:speciesTypeInstance multi:id="stiX3" multi:speciesType="stX" multi:occur="1" />
  </multi:listOfSpeciesTypeInstances>
  <multi:listOfSpeciesTypeComponentIndexes>
    <multi:speciesTypeComponentIndex multi:id="x1b1" multi:component="b"
      mult:identifyingParent="stiX1" multi:occur="1" />
    <multi:speciesTypeComponentIndex multi:id="x1b2" multi:component="b"
      mult:identifyingParent="stiX1" multi:occur="1" />
    <multi:speciesTypeComponentIndex multi:id="x2b1" multi:component="b"
      mult:identifyingParent="stiX2" multi:occur="1" />
    <multi:speciesTypeComponentIndex multi:id="x2b2" multi:component="b"
      mult:identifyingParent="stiX2" multi:occur="1" />
    <multi:speciesTypeComponentIndex multi:id="x3b1" multi:component="b"
      mult:identifyingParent="stiX3" multi:occur="1" />
    <multi:speciesTypeComponentIndex multi:id="x3b2" multi:component="b"
      mult:identifyingParent="stiX3" multi:occur="1" />
  </multi:listOfSpeciesTypeComponentIndexes>
  <multi:listOfInSpeciesTypeBonds>
    <multi:inSpeciesTypeBond multi:bindingSite1="x1b2" multi:bindingSite2="x2b1" />
    <multi:inSpeciesTypeBond multi:bindingSite1="x2b2" multi:bindingSite2="x3b1" />
  </multi:listOfInSpeciesTypeBonds>
</multi:speciesType>
</multi:listOfSpeciesTypes>
<listOfSpecies>
  <species id="spX" multi:speciesType="stX" ...>
    <multi:listOfOutwardBindingSites>
      <multi:outwardBindingSite multi:component="b1" multi:bindingStatus="unbound" />
      <multi:outwardBindingSite multi:component="b2" multi:bindingStatus="unbound" />
    </multi:listOfOutwardBindingSites>
    <multi:listOfSpeciesFeatures>
      <multi:speciesFeature multi:speciesFeatureType="A">
        <multi:listOfSpeciesFeatureValues>
          <multi:speciesFeatureValue multi:value="a1" />
        </multi:listOfSpeciesFeatureValues>
      </multi:speciesFeature>
    </multi:listOfSpeciesFeatures>
  </species>
  <species id="spY" multi:speciesType="stY" ... >
    <multi:listOfOutwardBindingSites>
      <multi:outwardBindingSite multi:component="x1b1" multi:bindingStatus="bound" />
      <multi:outwardBindingSite multi:component="x2b2" multi:bindingStatus="unbound" />
    </multi:listOfOutwardBindingSites>
    <multi:listOfSpeciesFeatures>
      <multi:speciesFeature multi:speciesFeatureType="A" multi:component="stiX1">
        <multi:listOfSpeciesFeatureValues>

```

```

        <multi:speciesFeatureValue value="a2" />
    </multi:listOfSpeciesFeatureValues>
</multi:speciesFeature>
<multi:speciesFeature multi:speciesFeatureType="A" multi:component="stiX2">
    <multi:listOfSpeciesFeatureValues>
        <multi:speciesFeatureValue value="a1" />
    </multi:listOfSpeciesFeatureValues>
</multi:speciesFeature>
</multi:listOfSpeciesFeatures>
</species>
<species id="spZ" multi:speciesType="st_z" ... >
    <multi:listOfOutwardBindingSites>
        <multi:outwardBindingSite multi:component="x1b1" multi:bindingStatus="bound" />
        <multi:outwardBindingSite multi:component="x3b2" multi:bindingStatus="unbound" />
    </multi:listOfOutwardBindingSites>
    <multi:listOfSpeciesFeatures>
        <multi:speciesFeature multi:speciesFeatureType="A" multi:component="stiX1">
            <multi:listOfSpeciesFeatureValues>
                <multi:speciesFeatureValue value="a2" />
            </multi:listOfSpeciesFeatureValues>
        </multi:speciesFeature>
        <multi:speciesFeature multi:speciesFeatureType="A" multi:component="stiX2">
            <multi:listOfSpeciesFeatureValues>
                <multi:speciesFeatureValue value="a1" />
            </multi:listOfSpeciesFeatureValues>
        </multi:speciesFeature>
        <multi:speciesFeature multi:speciesFeatureType="A" multi:component="stiX3">
            <multi:listOfSpeciesFeatureValues>
                <multi:speciesFeatureValue value="a1" />
            </multi:listOfSpeciesFeatureValues>
        </multi:speciesFeature>
    </multi:listOfSpeciesFeatures>
</species>
</listOfSpecies>
<listOfReactions>
    <reaction id="association" ...>
        <listOfReactants>
            <speciesReference id="reactantX" species="spX" />
            <speciesReference id="reactantY" species="spY" />
        </listOfReactants>
        <listOfProducts>
            <speciesReference id="productZ" species="spZ">
                <multi:listOfSpeciesTypeComponentMapsInProduct>
                    <multi:speciesTypeComponentMapInProduct multi:reactant="reactantY"
                        multi:reactantComponent="stiX1" multi:productComponent="stiX1" />
                    <multi:speciesTypeComponentMapInProduct multi:reactant="reactantY"
                        multi:reactantComponent="stiX2" multi:productComponent="stiX2" />
                    <multi:speciesTypeComponentMapInProduct multi:reactant="reactantX"
                        multi:reactantComponent="stX" multi:productComponent="stiX3" />
                </multi:listOfSpeciesTypeComponentMapsInProduct>
            </speciesReference>
        </listOfProducts>
        ...
    </reaction>
</listOfReactions>

```

6
7
8
9
10
11
12
13
14
15
16
17
18
19
20
21
22
23
24
25
26
27
28
29
30
31
32
33
34
35
36
37
38
39
40
41
42
43
44
45
46
47
48
49
50
51
52
53
54
55
56
1
2
3
4

3.25 SpeciesFeatureChange

SpeciesFeatureChange is defined in [Figure 16 on page 38](#) and provides a way to specify how some of or all instances of a **speciesFeatureType** to change. This class should only be used when the **occur** of the referenced **speciesFeatureType** is larger than “1”. The parent **components** of the changed **speciesFeatures** are identified in the [SpeciesTypeComponentMapInProduct](#) object. **SpeciesFeatureChange** has one optional attribute **id** and two required attributes, **reactantSpeciesFeature** and **productSpeciesFeature**. The **occur** attributes of the changed **speciesFeatures** in **reactant** and **product** respectively must have the same value.

Since **SpeciesFeatureChange** is derived from **SBase**, it inherits the **sboTerm** and **metaid** attributes, as well as the optional children **Notes** and **Annotation** objects.

3.25.1 The id attribute

The optional **id** attribute, of type **SId**, provides a way to identify a **speciesFeatureChange**.

3.25.2 The reactantSpeciesFeature attribute

The **reactantSpeciesFeature** attribute, of type **SIdRef**, references a **speciesFeature** in the **reactant component** in a reaction mapping.

3.25.3 The productSpeciesFeature attribute

The **productSpeciesFeature** attribute, of type **SIdRef**, references a **speciesFeature** in the **product component** in a reaction mapping.

3.25.4 Example

Here is an example to illustrate the use of the [SpeciesFeatureChange](#) class in a phosphorylation reaction. One among the five sites in a species is transformed from “unphosphorylated” to “phosphorylated” and the phosphorylation sites are defined as the referenced **speciesFeatureType** with **occur**=“5”. The SBML code can be as follows:

```

<multi:listOfSpeciesTypes>
  <multi:speciesType multi:id="stX" ... >
    <multi:listOfSpeciesFeatureTypes>
      <multi:speciesFeatureType multi:id="phosphorylation" multi:occur="5">
        <multilist:ListOfPossibleSpeciesFeatureValues>
          <multi:possibleSpeciesFeatureValue multi:id="phosphorylated" />
          <multi:possibleSpeciesFeatureValue multi:id="unphosphorylated" />
        </multilist:ListOfPossibleSpeciesFeatureValues>
      </multi:speciesFeatureType>
    </multi:listOfSpeciesFeatureTypes>
  </multi:speciesType>
</multi:listOfSpeciesTypes>
<listOfSpecies>
  <species id="spX1" multi:speciesType="stX">
    <multi:listOfSpeciesFeatures>
      <multi:speciesFeature multi:id="U"
        multi:speciesFeatureType="phosphorylation" multi:occur="1" >
        <multi:listOfSpeciesFeatureValues>
          <multi:speciesFeatureValue multi:value="unphosphorylated" />
        </multi:listOfSpeciesFeatureValues>
      </multi:speciesFeature>
    </multi:listOfSpeciesFeatures>
    ...
  </species>
  <species id="spX2" multi:speciesType="stX">
    <multi:listOfSpeciesFeatures>
      <multi:speciesFeature multi:id="P"
        multi:speciesFeatureType="phosphorylation" multi:occur="1" >

```

```

        <multi:listOfSpeciesFeatureValues>
          <multi:speciesFeatureValue multi:value="phosphorylated" />
        </multi:listOfSpeciesFeatureValues>
      </multi:speciesFeature>
    </multi:listOfSpeciesFeatures>
    ...
  </species>
</listOfSpecies>
<listOfReactions>
  <reaction id="transformation" ... >
    <listOfReactants>
      <speciesReference id="reactant" species="spX1" ... />
    </listOfReactants>
    <listOfProducts>
      <speciesReference id="product" species="spX2" ...>
        <multi:listOfSpeciesTypeComponentMapsInProduct>
          <multi:speciesTypeComponentMapInProduct multi:reactant="reactant"
            multi:reactantComponent="stX" multi:productComponent="stX">
            <multi:listOfSpeciesFeatureChanges>
              <multi:speciesFeatureChange multi:reactantSpeciesFeature="U"
                multi:productSpeciesFeature="P" />
            </multi:listOfSpeciesFeatureChanges>
          </multi:speciesTypeComponentMapInProduct>
        </multi:listOfSpeciesTypeComponentMapsInProduct>
      </speciesReference>
    </listOfProducts>
  </reaction>
</listOfReactions>

```

6
7
8
9
10
11
12
13
14
15
16
17
18
19
20
21
22
23
24
25
26
27
28
29
1
2
3
4
5

3.26 The outwardBindingSites and speciesFeatures in “don’t care” state in a reaction product

An outwardBindingSite is in “don’t care” state if its bindingStatus is “either” or is not specified (also see [Section 3.16.2 on page 25](#)). A speciesFeature or an instance of a speciesFeature (the occur of its speciesFeatureType is larger than “1”) is in “don’t care” state if it has all the possibleSpeciesFeatureValues under its speciesFeatureType, or it is not specified in the species (also see [Section 3.16.3 on page 26](#)).

For a species as a product in a reaction, if it has “don’t care” outwardBindingSites or “don’t care” speciesFeatures, the interpretation of the “don’t care” is “don’t change”. In a product, a “don’t care” outwardBindingSite has the same bindingStatus as the mapped outwardBindingSite in the reactant, and a “don’t care” speciesFeature or instance of a speciesFeature has the same value as the mapped speciesFeature or the mapped speciesFeature instance in the reactant.

For the phosphorylation example in [Section 3.25.4 on page 42](#), the reactant species has one “unphosphorylated” site and four “don’t care” sites, and the product species has one “phosphorylated” site and four don’t care sites. The “phosphorylation” reaction can apply to the following reactions of “fully defined” species.

- Reactant: a species with “0” phosphorylated site and “5” unphosphorylated sites.
Product: a species with “1” phosphorylated site and “4” unphosphorylated sites.
- Reactant: a species with “1” phosphorylated site and “4” unphosphorylated sites.
Product: a species with “2” phosphorylated sites and “3” unphosphorylated sites.
- Reactant: a species with “2” phosphorylated sites and “3” unphosphorylated sites.
Product: a species with “3” phosphorylated sites and “2” unphosphorylated sites.
- Reactant: a species with “3” phosphorylated sites and “2” unphosphorylated sites.
Product: a species with “4” phosphorylated sites and “1” unphosphorylated site.
- Reactant: a species with “4” phosphorylated sites and “1” unphosphorylated site.
Product: a species with “5” phosphorylated sites and “0” unphosphorylated site.

3.27 Extended ci elements in Math objects

The Multi package extends the ci element in **Math** in **Reaction** with optional attributes **speciesReference** and **representationType**.

3.27.1 The speciesReference attribute

The optional **speciesReference** attribute, of type **SIIDRef**, can only be used when the content of the **ci** element is a **species id**, or when the content of the **ci** element is a **speciesFeature id**. The **speciesReference** attribute can identify which **species** is referenced in a **reaction**.

If the **ci** content references a **species' id**, the **id** represent the concentration of the **species**.

If the **ci** content references a **speciesFeature's id**, the **id** represent the count of the **speciesFeature** instances with the **speciesFeatureValue** (also see [Section 3.18.1 on page 29](#)).

The example in [Section 3.22 on page 36](#) can be further extended with a block of **kineticLaw** in the **reaction** to illustrate the use of the **speciesReference** attribute with a **species' id**.

```
<reaction id="reaction" ... >
  ...
  <kineticLaw>
    <math xmlns="http://www.w3.org/1998/Math/MathML">
      <apply>
        <times />
        <ci> k </ci>
        <ci multi:speciesReference="r1"> spA </ci>
        <ci multi:speciesReference="m1"> spM </ci>
        <ci multi:speciesReference="r2"> spA </ci>
        <ci multi:speciesReference="m2"> spM </ci>
      </apply>
    </math>
    <listOfLocalParameters>
      <localParameter id="k" value="0.1" ... />
    </listOfLocalParameters>
  </kineticLaw>
</reaction>
```

Two “spA” species and two “spM” species are distinguished by the “r1” and “r2” **speciesReferences** respectively.

Here is another example to show the use of the **speciesReference** attribute for a possibleSpeciesFeatureValue. This example is a simplified adaptation of published models [[Malleshiah et al. \(2010\)](#), [Barik et al. \(2010\)](#)]. A species “Y” has 10 phosphorylation sites. It can be phosphorylated by another species “M” one site one time and the phosphorylation rate depends on the number of sites already phosphorylated in species “Y”. The SBML code can be as follows:

```
<multi:listOfSpeciesTypes>
  <multi:speciesType multi:id="stY" multi:occur="1" >
    <multi:listOfSpeciesFeatureType multi:id="phosphorylation" multi:occur="10" >
      <multi:listOfPossibleSpeciesFeatureValues>
        <multi:possibleSpeciesFeatureValue multi:id="P" multi:name="phosphorylated" />
        <multi:possibleSpeciesFeatureValue multi:id="U" multi:name="unphosphorylated" />
      </multi:listOfPossibleSpeciesFeatureValues>
    </multi:listOfSpeciesFeatureType>
  </multi:speciesType>
</multi:listOfSpeciesTypes>
<listOfSpecies>
  <species id="Yu" multi:speciesType="Y" ...>
    <multi:listOfSpeciesFeatures>
      <multi:speciesFeature multi:id="fU" multi:occur="1">
        <multi:listOfSpeciesFeatureValues>
          <multi:speciesFeatureValue value="U" />
        </multi:listOfSpeciesFeatureValues>
      </multi:speciesFeature>
    </multi:listOfSpeciesFeatures>
  </species>
</listOfSpecies>
```

```

        </multi:listOfSpeciesFeatureValues>
      </multi:speciesFeature>
    </multi:listOfSpeciesFeatures>
  </species>
  <species id="Yp" multi:speciesType="Y" ...>
    <multi:listOfSpeciesFeatures>
      <multi:speciesFeature multi:id="fP" multi:occur="1">
        <multi:listOfSpeciesFeatureValues>
          <multi:speciesFeatureValue value="P" />
        </multi:listOfSpeciesFeatureValues>
      </multi:speciesFeature>
    </multi:listOfSpeciesFeatures>
  </species>
</listOfSpecies>
<species id="M" ... />
</listOfSpecies>
<listOfReactions>
  <reaction id="reaction" .>
    <listOfReactants>
      <speciesReference id="r" species="Yu" />
    </listOfReactants>
    <listOfProducts>
      <speciesReference id="p" species="Yp" >
        <multi:listOfSpeciesTypeComponentMapsInProduct>
          <multi:speciesTypeComponentMapInProduct multi:reactant="r"
            multi:reactantComponent="stY" multi:productReactant="stY" >
            <multi:listOfSpeciesFeatureChanges>
              <multi:speciesFeatureChange multi:reactantSpeciesFeature="fU"
                multi:productSpeciesFeature="fP" />
            </multi:listOfSpeciesFeatureChanges>
          </multi:speciesTypeComponentMapInProduct>
        </multi:listOfSpeciesTypeComponentMapsInProduct>
      </speciesReference>
    </listOfProducts>
    <listOfModifierSpeciesReferences>
      <modifierSpeciesReference species="M" />
    </listOfModifierSpeciesReferences>
    <kineticLaw>
      <math xmlns="http://www.w3.org/1998/Math/MathML">
        <apply>
          <times />
          <ci> k </ci>
          <ci> Yu </ci>
          <ci> M </ci>
          <ci multi:speciesReference="r"> P </ci>
        </apply>
      </math>
    </kineticLaw>
  </reaction>
</listOfReactions>

```

Any “fully defined” species referencing “Y” with at least one unphosphorylated site maps to the species “Yu”. Any “fully defined” species referencing “Y” with at least one phosphorylated site maps to the species “Yp”. The `speciesFeatureChange` references speciesFeatures “fU” and “fP” and the value of “1” for both `occur` attributes of “fU” and “fP” indicates that one site is phosphorylated in the reaction. The `<ci multi:speciesReference="r"> P </ci>` depends on the “fully defined” species mapping to the species “Yu” which is referenced by the speciesReference “r”. If the “fully defined” species has 1 site phosphorylated, the `ci` is “1” in the math, similarly, `ci` is 2 for 2 phosphorylated sites, ..., `ci` is 9 for 9 phosphorylated sites.

3.27.2 The `representationType` attribute

The optional `representationType` attribute, of type `RepresentationType`, can only be used when the content of the `ci` element is a species' id or a possibleSpeciesFeatureValue's id. The `representationType` and `speciesReference` attributes can both be used for the same `ci` element at the same time.

The `representationType` attribute can only have the value of "sum" when the content of the `ci` is `species`. The interpretation of such a `ci` element is the total concentration or amount of all "fully defined" species (see [Section 3.19 on page 34](#)) mapping to the referenced pattern `species`.

The `representationType` attribute can have the value of "numericValue" when the content of the `ci` is `possibleSpeciesFeatureValue` and the `speciesReference` attribute must be defined. The interpretation of such a `ci` is the same as a `ci` element having a `parameter` which the `possibleSpeciesFeatureValue` links via its `numericValue` attribute.

The following example demonstrates the use of this attribute for "sum" of `species` concentrations.

$$k_1 \text{Si} / (k_2 + \text{SUM}(\text{Si}))$$

In this example, the reactant "Si" is a pattern `species` which may have multiple "fully defined" species mapping to it, for example `species` "S1", "S2", ..., "Sn". "SUM(Si)" is a function to calculate the total concentration of all "fully defined" species mapping to "Si". The product can be another pattern `species` "Pi". The SBML code for the math expression can be as follows:

```
<reaction id="r">
  <listOfReactants>
    <speciesReference species="Si" />
  </listOfReactants>
  <listOfProducts>
    <speciesReference species="Pi" />
  </listOfProducts>
  <kineticLaw>
    <math xmlns="http://www.w3.org/1998/Math/MathML">
      <apply>
        <divide>
          <apply>
            <times />
            <ci>Si</ci>
            <ci>k1</ci>
          </apply>
          <apply>
            <plus />
            <ci>k2</ci>
            <ci multi:representationType="sum">Si</ci>
          </apply>
        </divide>
      </apply>
    </math>
    <listOfLocalParameters>
      <localParameter id="k1" ... />
      <localParameter id="k2" .... />
    </listOfLocalParameters>
  </kineticLaw>
</reaction>
```

The math expressions for the individual `species` in the example can be:

```
For species S1:   k1*S1/(k2 + (S1 + S2 + ... + Sn))
For species S2:   k1*S2/(k2 + (S1 + S2 + ... + Sn))
...
For species Sn:   k1*Sn/(k2 + (S1 + S2 + ... + Sn))
```

3.28 Namespace scoping rules for identifiers

In the Multi package, as in SBML Level 3 Version 1 Core, the **Model** object contains the main components of an SBML model, such as the species, compartments and reactions. The package defines new classes within a model and the scope of identifiers of those new classes should be defined to prevent identifier collisions. In this section, we describe the scoping rules for all of the types and classes defined in Section 3.4 to Section 3.27 on pages 9–45.

1. The namespace for **SId** identifiers defined within a **Model** object used in the Multi package follows the same rules as those defined in SBML Level 3 Version 1 Core for plain **Model** objects. The scope of the identifiers is limited to the enclosing **Model** object.
2. The identifier of every **SpeciesType** object defined in the Multi package must be unique across the set of all identifiers in the **Model** object in which it is located.
3. The identifier of every **SpeciesTypeInstance**, **SpeciesTypeComponentIndex**, **InSpeciesTypeBond** and **PossibleSpeciesFeatureValue** object defined in the Multi package must be unique across the set of all identifiers in the **SpeciesType** object in which it is located.
4. The identifier of every **SpeciesFeature** object defined in the Multi package must be unique across the set of all identifiers in the **Species** object in which it is located.
5. The identifier, if defined, of every **SpeciesFeatureChange** object defined in the Multi package must be unique across the set of all identifiers in the **SpeciesTypeComponentMapInProduct** object in which it is located.
6. The identifier, if defined, of every **CompartmentReference** object defined in the Multi package must be unique across the set of all identifiers in the **Compartment** object in which it is located.

4 Examples

This section contains examples employing the Multi package for SBML Level 3.

4.1 Example: **Compartment, SpeciesType and Species**

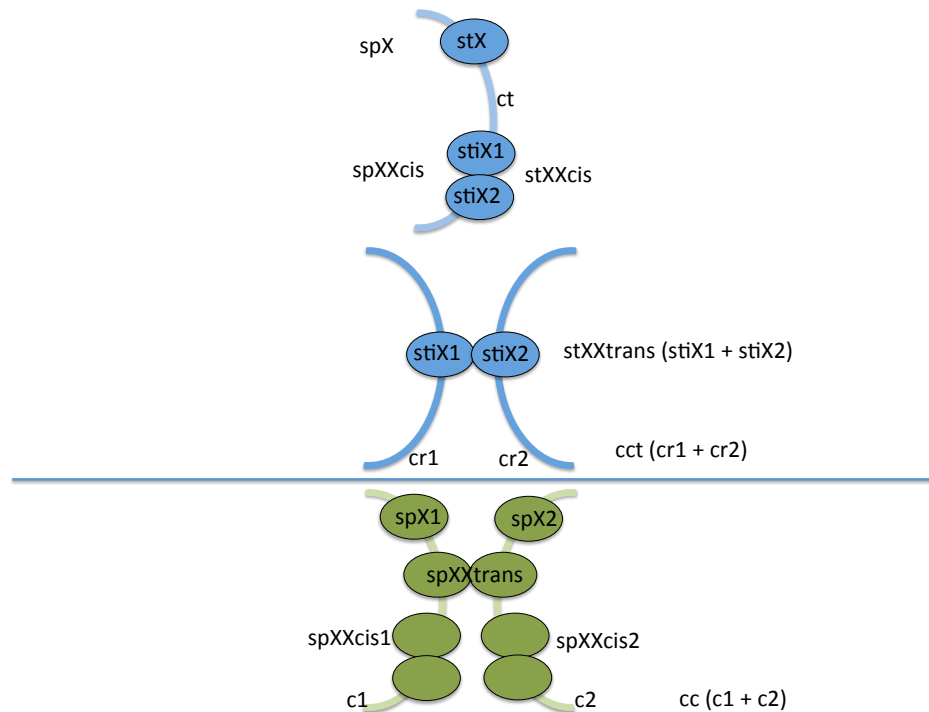

Figure 18: Diagram for an example of **Compartment, SpeciesType and Species**

Figure 18 shows an example illustrating the usages of and relations among the **Compartment, SpeciesType and Species** classes.

“ct” is a compartment type. “cct” is a composite compartment type with two compartmentReferences “cr1” and “cr2” both referencing “ct”. “c1” is a “not-a-type” compartment and references “ct”. Similarly, “c2” is also a “not-a-type” compartment and references “ct”. “cc” is a composite “not-a-type” compartment composed of “c1” and “c2”.

“stX” is a speciesType on the “ct” compartment. “stXXcis” is a speciesType on the “ct” compartment, and has two speciesTypeInstances “stiX1” and “stiX2” both of that reference the “stX” speciesType. “stXXtrans” is a speciesType on the “cct” compartment with two speciesTypeInstances “stiX1” and “stiX2” sitting in different sub-compartments.

“spX” is a species referencing speciesType “stX”. “spXXcis” is a species referencing “stXXcis”. “spX1” is a species referencing “stX” and sitting in the “c1” compartment. “spX2” is a species also referencing “stX”, but sitting in “c2”. “spXXtrans” is a species referencing “stXXtrans”. “spXXcis1” is a species referencing “stXXtrans” and sitting in “c1”. “spXXcis2” is a species referencing “stXXtrans” and sitting in “c2”.

“spX1”, “spX2”, “spXXtrans”, “spXXcis1” and “spXXcis2” are “fully defined” species (see Section 3.19 on page 34).

The SBML code can be as follows:

```

<listOfCompartments>
  <compartment id="ct" multi:isType="true" />
  <compartment id="cct" multi:isType="true">
    <multi:listOfCompartmentReferences>
      <multi:compartmentReference multi:id="cr1" multi:compartment="ct" />
      <multi:compartmentReference multi:id="cr2" multi:compartment="ct" />
    </multi:listOfCompartmentReferences>
  </compartment>
  <compartment id="c1" multi:isType="false" multi:compartmentType="ct" />
  <compartment id="c2" multi:isType="false" multi:compartmentType="ct" />
  <compartment id="cc" multi:isType="false" multi:compartmentType="cct">
    <multi:listOfCompartmentReferences>
      <multi:compartmentReference multi:compartment="c1" />
      <multi:compartmentReference multi:compartment="c2" />
    </multi:listOfCompartmentReferences>
  </compartment>
</listOfCompartments>
<multi:listOfSpeciesTypes>
  <multi:bindingSiteSpeciesType multi:id="stX" multi:compartment="ct" />
  <multi:speciesType multi:id="stXXcis" multi:compartment="ct">
    <multi:listOfSpeciesTypeInstances>
      <multi:speciesTypeInstance multi:id="stiX1" multi:speciesType="stX" multi:occur="1" />
      <multi:speciesTypeInstance multi:id="stiX2" multi:speciesType="stX" multi:occur="1" />
    </multi:listOfSpeciesTypeInstances>
    <multi:listOfInSpeciesTypeBonds>
      <multi:inSpeciesTypeBond multi:bindingSite1="stiX1" multi:bindingSite2="stiX2" />
    </multi:listOfInSpeciesTypeBonds>
  </multi:speciesType>
  <multi:speciesType multi:id="stXXtrans" multi:compartment="cct">
    <multi:listOfSpeciesTypeInstances>
      <multi:speciesTypeInstance multi:id="stiX1" multi:speciesType="stX"
        multi:compartmentReference="cr1" multi:occur="1" />
      <multi:speciesTypeInstance multi:id="stiX2" multi:speciesType="stX"
        multi:compartmentReference="cr2" multi:occur="1" />
    </multi:listOfSpeciesTypeInstances>
    <multi:listOfInSpeciesTypeBonds>
      <multi:inSpeciesTypeBond multi:bindingSite1="stiX1" multi:bindingSite2="stiX2" />
    </multi:listOfInSpeciesTypeBonds>
  </multi:speciesType>
</multi:listOfSpeciesTypes>
<listOfSpecies>
  <species id="spX" multi:speciesType="stX" compartment="ct" />
  <species id="spXXcis" multi:speciesType="stXXcis" compartment="ct" />
  <species id="spX1" multi:speciesType="stX" compartment="c1" /> <!-- Fully defined -->
  <species id="spX2" multi:speciesType="stX" compartment="c2" /> <!-- Fully defined -->
  <species id="spXXtrans" multi:speciesType="stXXtrans" compartment="cc" /> <!-- Fully defined -->
  <species id="spXXcis1" multi:speciesType="stXXcis" compartment="c1" /> <!-- Fully defined -->
  <species id="spXXcis2" multi:speciesType="stXXcis" compartment="c2" /> <!-- Fully defined -->
</listOfSpecies>

```

4.2 *Simmune* example: the Ecad model

The *Simmune* toolset (<http://go.usa.gov/QeH>) has some example models including the published Ecad model [Angermann et al. (2012)]. The Ecad model describes the interactions between E-cadherin receptors that can associate either with other E-cadherin receptors within the same membrane (in “cis”) or with E-cadherin receptors on adjacent membranes (in “trans”). This model is transformed into the SBML Level 3 format with use of the Multi package.

```
<?xml version="1.0" encoding="UTF-8"?>
```

```

7 <sbml xmlns="http://www.sbml.org/sbml/level3/version1/core" level="3" version="1"
8   xmlns:multi="http://www.sbml.org/sbml/level3/version1/multi/version1" multi:required="true">
9   <model name="E-cadherin_mediated_adhesion">
10
11     <!-- Definitions -->
12     <listOfUnitDefinitions>
13       <unitDefinition id="litre_per_mole_per_sec">
14         <listOfUnits>
15           <unit kind="litre" exponent="1" scale="0" multiplier="1" />
16           <unit kind="mole" exponent="-1" scale="0" multiplier="1" />
17           <unit kind="second" exponent="-1" scale="0" multiplier="1" />
18         </listOfUnits>
19       </unitDefinition>
20       <unitDefinition id="micron_square_per_sec">
21         <listOfUnits>
22           <unit kind="metre" exponent="2" scale="-6" multiplier="1" />
23           <unit kind="second" exponent="-1" scale="0" multiplier="1" />
24         </listOfUnits>
25       </unitDefinition>
26       <unitDefinition id="micrometre_per_sec">
27         <listOfUnits>
28           <unit kind="metre" exponent="1" scale="-6" multiplier="1" />
29           <unit kind="second" exponent="-1" scale="0" multiplier="1" />
30         </listOfUnits>
31       </unitDefinition>
32       <unitDefinition id="per_sec">
33         <listOfUnits>
34           <unit kind="second" exponent="-1" scale="0" multiplier="1" />
35         </listOfUnits>
36       </unitDefinition>
37     </listOfUnitDefinitions>
38
39     <!-- Compartments -->
40     <listOfCompartments>
41       <compartment id="membrane" constant="true" multi:isType="true" />
42       <compartment id="inter_membrane" constant="true" multi:isType="true">
43         <multi:listOfCompartmentReferences>
44           <multi:compartmentReference multi:id="m1" multi:compartment="membrane" />
45           <multi:compartmentReference multi:id="m2" multi:compartment="membrane" />
46         </multi:listOfCompartmentReferences>
47       </compartment>
48     </listOfCompartments>
49
50     <!-- SpeciesTypes -->
51     <multi:listOfSpeciesTypes>
52
53       <!-- Ecad with cis-binding site and trans-binding site: -->
54       <multi:bindingSiteSpeciesType multi:id="st_Cis_Interface" />
55       <multi:bindingSiteSpeciesType multi:id="st_Trans_Interface" />
56       <multi:speciesType multi:id="st_Ecad" multi:compartment="membrane">
57         <multi:listOfSpeciesTypeInstances>
58           <multi:speciesTypeInstance multi:id="cis" multi:speciesType="st_Cis_Interface"
59             multi:occur="1" />
60           <multi:speciesTypeInstance multi:id="trans" multi:speciesType="st_Trans_Interface"
61             multi:occur="1" />
62         </multi:listOfSpeciesTypeInstances>
63       </multi:speciesType>
64
65       <!-- cis dimer: -->
66       <multi:speciesType multi:id="st_Ecad_cis_dimer" multi:compartment="membrane">
67         <multi:listOfSpeciesTypeInstances>
68           <multi:speciesTypeInstance multi:id="Ecad1" multi:speciesType="st_Ecad"
69             multi:occur="1" />
70           <multi:speciesTypeInstance multi:id="Ecad_2" multi:speciesType="st_Ecad"
71             multi:occur="1" />
72         </multi:listOfSpeciesTypeInstances>

```

```

<multi:listOfSpeciesTypeComponentIndexes>
  <multi:speciesTypeComponentIndex multi:id="Ecad1cis"
    multi:component="cis" multi:identifyingParent="Ecad1" multi:occur="1" />
  <multi:speciesTypeComponentIndex multi:id="Ecad2cis"
    multi:component="cis" multi:identifyingParent="Ecad2" multi:occur="1" />
  <multi:speciesTypeComponentIndex multi:id="Ecad1trans"
    multi:component="trans" multi:identifyingParent="Ecad1" multi:occur="1" />
  <multi:speciesTypeComponentIndex multi:id="Ecad2trans"
    multi:component="trans" multi:identifyingParent="Ecad2" multi:occur="1" />
</multi:listOfSpeciesTypeComponentIndexes>
<multi:listOfInSpeciesTypeBonds>
  <multi:inSpeciesTypeBond multi:bindingSite1="Ecad1cis"
    multi:bindingSite2="Ecad2cis" />
</multi:listOfInSpeciesTypeBonds>
</multi:speciesType>

<!-- trans dimer: -->
<multi:speciesType multi:id="st_Ecad_trans_dimer" multi:compartment="inter_membrane">
  <multi:listOfSpeciesTypeInstances>
    <multi:speciesTypeInstance multi:id="Ecad1" multi:speciesType="st_Ecad"
      multi:compartmentReference="m1" multi:occur="1" />
    <multi:speciesTypeInstance multi:id="Ecad2" multi:speciesType="st_Ecad"
      multi:compartmentReference="m2" multi:occur="1" />
  </multi:listOfSpeciesTypeInstances>
  <multi:listOfSpeciesTypeComponentIndexes>
    <multi:speciesTypeComponentIndex multi:id="Ecad1trans"
      multi:component="trans" multi:identifyingParent="Ecad1" multi:occur="1" />
    <multi:speciesTypeComponentIndex multi:id="Ecad2trans"
      multi:component="trans" multi:identifyingParent="Ecad2" multi:occur="1" />
    <multi:speciesTypeComponentIndex multi:id="Ecad1cis"
      multi:component="cis" multi:identifyingParent="Ecad1" multi:occur="1" />
    <multi:speciesTypeComponentIndex multi:id="Ecad2cis"
      multi:component="cis" multi:identifyingParent="Ecad2" multi:occur="1" />
  </multi:listOfSpeciesTypeComponentIndexes>
  <multi:listOfInSpeciesTypeBonds>
    <multi:inSpeciesTypeBond multi:bindingSite1="Ecad1trans"
      multi:bindingSite2="Ecad2trans" />
  </multi:listOfInSpeciesTypeBonds>
</multi:speciesType>

<!-- trimer: -->
<multi:speciesType multi:id="st_Ecad_trimer" multi:compartment="inter_membrane">
  <multi:listOfSpeciesTypeInstances>
    <multi:speciesTypeInstance multi:id="Ecad1" multi:speciesType="st_Ecad"
      multi:compartmentReference="m1" multi:occur="1" />
    <multi:speciesTypeInstance multi:id="Ecad2" multi:speciesType="st_Ecad"
      multi:compartmentReference="m1" multi:occur="1" />
    <multi:speciesTypeInstance multi:id="Ecad3" multi:speciesType="st_Ecad"
      multi:compartmentReference="m2" multi:occur="1" />
  </multi:listOfSpeciesTypeInstances>
  <multi:listOfSpeciesTypeComponentIndexes>
    <multi:speciesTypeComponentIndex multi:id="Ecad1cis"
      multi:component="cis" multi:identifyingParent="Ecad1" multi:occur="1" />
    <multi:speciesTypeComponentIndex multi:id="Ecad1trans"
      multi:component="trans" multi:identifyingParent="Ecad1" multi:occur="1" />
    <multi:speciesTypeComponentIndex multi:id="Ecad2cis"
      multi:component="cis" multi:identifyingParent="Ecad2" multi:occur="1" />
    <multi:speciesTypeComponentIndex multi:id="Ecad2trans"
      multi:component="trans" multi:identifyingParent="Ecad2" multi:occur="1" />
    <multi:speciesTypeComponentIndex multi:id="Ecad3cis"
      multi:component="cis" multi:identifyingParent="Ecad3" multi:occur="1" />
    <multi:speciesTypeComponentIndex multi:id="Ecad3trans"
      multi:component="trans" multi:identifyingParent="Ecad3" multi:occur="1" />
  </multi:listOfSpeciesTypeComponentIndexes>
  <multi:listOfInSpeciesTypeBonds>
    <multi:inSpeciesTypeBond multi:bindingSite1="Ecad1cis"

```

```

        multi:bindingSite2="Ecad2cis" />
        <multi:inSpeciesTypeBond multi:bindingSite1="Ecad1trans"
        multi:bindingSite2="Ecad3trans" />
    </multi:listOfInSpeciesTypeBonds>
</multi:speciesType>
</multi:listOfSpeciesTypes>

<!-- Species -->
<listOfSpecies>

    <!-- free Ecad -->
    <species id="sp_Ecad_unbound" name="Ecad_unbound" compartment="membrane"
    hasOnlySubstanceUnits="false" boundaryCondition="false" constant="false"
    multi:speciesType="st_Ecad">
        <multi:listOfOutwardBindingSites>
            <multi:outwardBindingSite multi:component="cis"
            multi:bindingStatus="unbound" />
            <multi:outwardBindingSite multi:component="trans"
            multi:bindingStatus="unbound" />
        </multi:listOfOutwardBindingSites>
    </species>

    <!-- Pattern species: Ecad trans unbd -->
    <species id="sp_Ecad_trans_unbnd" name="Ecad_trans_unbnd" compartment="membrane"
    hasOnlySubstanceUnits="false" boundaryCondition="false" constant="false"
    multi:speciesType="st_Ecad">
        <multi:listOfOutwardBindings>
            <multi:outwardBindingSite multi:component="trans"
            multi:bindingStatus="unbound" />
        </multi:listOfOutwardBindings>
    </species>

    <!-- Pattern species: Ecad trans bnd -->
    <species id="sp_Ecad_trans_bnd" name="Ecad_trans_bnd" compartment="membrane"
    hasOnlySubstanceUnits="false" boundaryCondition="false" constant="false"
    multi:speciesType="st_Ecad">
        <multi:listOfOutwardBindings>
            <multi:outwardBindingSite multi:component="trans"
            multi:bindingStatus="bound" />
        </multi:listOfOutwardBindings>
    </species>

    <!-- Pattern species: Ecad all -->
    <species id="sp_Ecad_all" name="Ecad_all" compartment="membrane"
    hasOnlySubstanceUnits="false"
    boundaryCondition="false" constant="false" multi:speciesType="st_Ecad" />

    <!-- Pattern species: Ecad cis unbnd -->
    <species id="sp_Ecad_cis_unbnd" name="Ecad_cis_unbnd" compartment="membrane"
    hasOnlySubstanceUnits="false" boundaryCondition="false" constant="false"
    multi:speciesType="st_Ecad">
        <multi:listOfOutwardBindings>
            <multi:outwardBindingSite multi:component="cis"
            multi:bindingStatus="unbound" />
        </multi:listOfOutwardBindings>
    </species>

    <!-- Pattern species: Ecad cis unbnd, trans bnd -->
    <species id="sp_Ecad_6" name="Ecad_6" compartment="membrane" hasOnlySubstanceUnits="false"
    boundaryCondition="false" constant="false" multi:speciesType="st_Ecad">
        <multi:listOfOutwardBindings>
            <multi:outwardBindingSite multi:component="cis"
            multi:bindingStatus="unbound" />
            <multi:outwardBindingSite multi:component="trans"
            multi:bindingStatus="bound" />
        </multi:listOfOutwardBindings>

```

```

7 </species>
8
9 <!-- Pattern species: Ecad cis bnd, trans unbnd -->
10 <species id="sp_Ecad_7" name="Ecad_7" compartment="membrane" hasOnlySubstanceUnits="false"
11 boundaryCondition="false" constant="false" multi:speciesType="st_Ecad">
12   <multi:listOfOutwardBindings>
13     <multi:outwardBindingSite multi:component="cis"
14       multi:bindingStatus="bound" />
15     <multi:outwardBindingSite multi:component="trans"
16       multi:bindingStatus="unbound" />
17   </multi:listOfOutwardBindings>
18 </species>
19
20 <!-- Pattern species: Ecad cis dimer -->
21 <species id="sp_Ecad_cis_dimer" name="Ecad_cis_dimer" compartment="membrane"
22   hasOnlySubstanceUnits="false" boundaryCondition="false" constant="false"
23   multi:speciesType="st_Ecad_cis_dimer" />
24
25 <!-- Pattern species: Ecad cis dimer: all trans bnd -->
26 <species id="sp_EcadEcad_2" name="Ecad.Ecad_2" compartment="membrane"
27   hasOnlySubstanceUnits="false" boundaryCondition="false" constant="false"
28   multi:speciesType="st_Ecad_cis_dimer">
29   <multi:listOfOutwardBindings>
30     <multi:outwardBindingSite multi:component="Ecad1trans"
31       multi:bindingStatus="bound" />
32     <multi:outwardBindingSite multi:component="Ecad2trans"
33       multi:bindingStatus="bound" />
34   </multi:listOfOutwardBindings>
35 </species>
36
37 <!-- Pattern species: Ecad trans dimer -->
38 <species id="sp_EcadEcad_1" name="Ecad.Ecad_1" compartment="inter_membrane"
39   hasOnlySubstanceUnits="false" boundaryCondition="false" constant="false"
40   multi:speciesType="st_Ecad_trans_dimer" />
41
42 <!-- Pattern species: Ecad trans dimer: all cis bnd -->
43 <species id="sp_Ecad_trans_dimer_2" name="Ecad_trans_dimer_2" compartment="inter_membrane"
44   hasOnlySubstanceUnits="false" boundaryCondition="false" constant="false"
45   multi:speciesType="st_Ecad_trans_dimer">
46   <multi:listOfOutwardBindings>
47     <multi:outwardBindingSite multi:component="Ecad1cis"
48       multi:bindingStatus="bound" />
49     <multi:outwardBindingSite multi:component="Ecad2cis"
50       multi:bindingStatus="bound" />
51   </multi:listOfOutwardBindings>
52 </species>
53
54 <!-- Pattern species: Ecad True Trimer -->
55 <species id="sp_Ecad_True_Tramer" compartment="inter_membrane" hasOnlySubstanceUnits="false"
56   boundaryCondition="false" constant="false" multi:speciesType="st_Ecad_trimer">
57   <multi:listOfOutwardBindings>
58     <multi:outwardBindingSite multi:component="Ecad2trans"
59       multi:bindingStatus="unbound" />
60     <multi:outwardBindingSite multi:component="Ecad3cis"
61       multi:bindingStatus="unbound" />
62   </multi:listOfOutwardBindings>
63 </species>
64
65 <!-- Pattern species: Ecad All Trimer -->
66 <species id="sp_Ecad_All_Tramer" compartment="inter_membrane" hasOnlySubstanceUnits="false"
67   boundaryCondition="false" constant="false" multi:speciesType="st_Ecad_trimer" />
68 </listOfSpecies>
69
70 <!-- Reactions -->
71 <listOfReactions>

```

```

7
8
9
10
11
12
13
14
15
16
17
18
19
20
21
22
23
24
25
26
27
28
29
30
31
32
33
34
35
36
37
38
39
40
41
42
43
44
45
46
47
48
49
50
51
52
53
54
55
56
57
58
59
60
61
62
63
64
65
66
1
2
3
4
5
6

```

```

<!-- cis association: -->
<reaction id="rc_Cis_Association" name="Cis_Association" reversible="false" fast="false"
  compartment="membrane">
  <listOfReactants>
    <speciesReference id="Cis_Association_r1" species="sp_Ecad_6"
      stoichiometry="1" constant="false" />
    <speciesReference id="Cis_Association_r2" species="sp_Ecad_6"
      stoichiometry="1" constant="false" />
  </listOfReactants>
  <listOfProducts>
    <speciesReference species="sp_EcadEcad_2" constant="false" />
  </listOfProducts>
  <kineticLaw>
    <math xmlns="http://www.w3.org/1998/Math/MathML">
      <apply>
        <times />
        <ci> kon </ci>
        <ci multi:speciesReference="Cis_Association_r1"> sp_Ecad_6 </ci>
        <ci multi:speciesReference="Cis_Association_r2"> sp_Ecad_6 </ci>
      </apply>
    </math>
    <listOfLocalParameters>
      <localParameter id="kon" value="9000" units="litre_per_mole_per_sec" />
    </listOfLocalParameters>
  </kineticLaw>
</reaction>

<!-- In species cis association: Here the model requires that the two interacting molecules
are part of one connected complex already prior to the association. Since the necessary
connectivity can only be mediated by the trans binding sites here, these sites must be
bound to the subcomplex (not shown) linking the two interacting molecules.
-->
<multi:intraSpeciesReaction id="rc_Intra_Complex_Cis_Association"
  name="Intra-Complex_Cis_Association"
  reversible="false" fast="false" compartment="membrane">
  <listOfReactants>
    <speciesReference id="Intra_Complex_Cis_Association_r1" species="sp_Ecad_6"
      stoichiometry="1" constant="false" />
    <speciesReference id="Intra_Complex_Cis_Association_r2" species="sp_Ecad_6"
      stoichiometry="1" constant="false" />
  </listOfReactants>
  <listOfProducts>
    <speciesReference species="sp_EcadEcad_2" constant="false" />
  </listOfProducts>
  <kineticLaw>
    <math xmlns="http://www.w3.org/1998/Math/MathML">
      <apply>
        <times />
        <ci> kon </ci>
        <ci multi:speciesReference="Intra_Complex_Cis_Association_r1"> sp_Ecad_6 </ci>
      </apply>
    </math>
    <listOfLocalParameters>
      <localParameter id="kon" value="100" units="per_sec" />
    </listOfLocalParameters>
  </kineticLaw>
</multi:intraSpeciesReaction>

<!-- trans association: -->
<reaction id="rc_Trans_Association" name="Trans_Association" reversible="false" fast="false"
  compartment="inter_membrane">
  <listOfReactants>
    <speciesReference id="Trans_Association_r1" species="sp_Ecad_trans_unbnd"
      compartmentReference="m1" constant="false" />
    <speciesReference id="Trans_Association_r2" species="sp_Ecad_trans_unbnd"
      compartmentReference="m2" constant="false" />
  </listOfReactants>

```



```

</listOfReactants>
<listOfProducts>
  <speciesReference species="sp_EcadEcad_1" constant="false" />
</listOfProducts>
<kineticLaw>
  <math xmlns="http://www.w3.org/1998/Math/MathML">
    <apply>
      <times />
      <ci> kon </ci>
      <ci multi:speciesReference="Trans_Association_r1"> sp_Ecad_trans_unbnd </ci>
      <ci multi:speciesReference="Trans_Association_r2"> sp_Ecad_trans_unbnd </ci>
    </apply>
  </math>
  <listOfLocalParameters>
    <localParameter id="kon" value="90000" units="litre_per_mole_per_sec" />
  </listOfLocalParameters>
</kineticLaw>
</reaction>

<!-- In complex trans association: Here the model requires that the two interacting molecules
are part of one connected complex already prior to the association. Since the necessary
connectivity can only be mediated by the cis binding sites here, these sites must be bound
to the subcomplex (not shown) linking the two interacting molecules.
-->
<multi:intraSpeciesReaction id="rc_Intra_Complex_Trans_Association"
name="Intra-Complex_Trans_Association"
reversible="false" fast="false" compartment="inter_membrane" >
  <listOfReactants>
    <speciesReference id="Intra_Complex_Trans_Association_r1" species="sp_Ecad_7"
      compartmentReference="m1" constant="false" />
    <speciesReference id="Intra_Complex_Trans_Association_r2" species="sp_Ecad_7"
      compartmentReference="m2" constant="false" />
  </listOfReactants>
  <listOfProducts>
    <speciesReference species="sp_Ecad_trans_dimer_2" constant="false" />
  </listOfProducts>
  <kineticLaw>
    <math xmlns="http://www.w3.org/1998/Math/MathML">
      <apply>
        <times />
        <ci> kon </ci>
        <ci multi:speciesReference="Intra_Complex_Trans_Association_r1"> sp_Ecad_7 </ci>
      </apply>
    </math>
    <listOfLocalParameters>
      <localParameter id="kon" value="100" units="per_sec" />
    </listOfLocalParameters>
  </kineticLaw>
</multi:intraSpeciesReaction>

<!-- cis dissociation: -->
<reaction id="rc_Cis_dissociation" name="Cis_dissociation" reversible="false" fast="false"
compartment="membrane">
  <listOfReactants>
    <speciesReference species="sp_Ecad_cis_dimer" constant="false" />
  </listOfReactants>
  <listOfProducts>
    <speciesReference id="Cis_dissociation_p1" species="sp_Ecad_cis_unbnd"
      stoichiometry="1" constant="false" />
    <speciesReference id="Cis_dissociation_p2" species="sp_Ecad_cis_unbnd"
      stoichiometry="1" constant="false" />
  </listOfProducts>
  <kineticLaw>
    <math xmlns="http://www.w3.org/1998/Math/MathML">
      <apply>
        <times />

```

```

        <ci> koff </ci>
        <ci> sp_Ecad_cis_unbnd </ci>
    </apply>
</math>
<listOfLocalParameters>
    <localParameter id="koff" value="1" units="per_sec" />
</listOfLocalParameters>
</kineticLaw>
</reaction>

<!-- In-species cis dissociation: By specifying that this reaction breaks only an inner bond,
the model limits the application of this reaction to dissociations that result in only one
reaction product. The complex is still connected through a subcomplex that is not shown
here but that links the two molecules involved in the reaction at their trans binding
sites. Note that the modeler application has to ensure the correct application of this
rule and its consistent definition. For instance, specifying the one or both of the trans
binding sites to be unbound would lead to a rule that could never be applied because the
trans bindings are required for the connectivity of the result complex.
-->
<multi:intraSpeciesReaction id="rc_Intra_Complex_Cis_dissociation"
name="Intra-Complex_Cis_dissociation"
    reversible="false" fast="false" compartment="membrane" >
    <listOfReactants>
        <speciesReference species="sp_EcadEcad_2" constant="false" />
    </listOfReactants>
    <listOfProducts>
        <speciesReference id="Intra_Complex_Cis_dissociation_p1" species="sp_Ecad_6"
            stoichiometry="2" constant="false" />
        <speciesReference id="Intra_Complex_Cis_dissociation_p2" species="sp_Ecad_6"
            stoichiometry="2" constant="false" />
    </listOfProducts>
    <kineticLaw>
        <math xmlns="http://www.w3.org/1998/Math/MathML">
            <apply>
                <times />
                <ci> koff </ci>
                <ci> sp_Ecad_6 </ci>
            </apply>
        </math>
        <listOfLocalParameters>
            <localParameter id="koff" value="0.01" units="per_sec" />
        </listOfLocalParameters>
    </kineticLaw>
</multi:intraSpeciesReaction>

<!-- trans dissociation: -->
<reaction id="rc_Trans_dissociation" name="Trans_dissociation" reversible="false"
fast="false" compartment="inter_membrane">
    <listOfReactants>
        <speciesReference species="sp_EcadEcad_1" constant="false" />
    </listOfReactants>
    <listOfProducts>
        <speciesReference id="Trans_dissociation_p1" species="sp_Ecad_trans_unbnd"
            multi:compartmentReference="m1" constant="false" />
        <speciesReference id="Trans_dissociation_p2" species="sp_Ecad_trans_unbnd"
            multi:compartmentReference="m2" constant="false" />
    </listOfProducts>
    <kineticLaw>
        <math xmlns="http://www.w3.org/1998/Math/MathML">
            <apply>
                <times />
                <ci> koff </ci>
                <ci> sp_Ecad_trans_unbnd </ci>
            </apply>
        </math>
        <listOfLocalParameters>

```

```

        <localParameter id="koff" value="1" units="per_sec" />
      </listOfLocalParameters>
    </kineticLaw>
  </reaction>

  <!-- In species trans dissociation: By specifying that this reaction breaks only an inner
  bond, the model limits the application of this reaction to dissociations that result in
  only one reaction product. The complex is still connected through a subcomplex that is
  not shown here but that links the two molecules involved in the reaction at their cis
  binding sites. Note that the modeler application has to ensure the correct application
  of this rule and its consistent definition. For instance, specifying the one or both of
  the cis binding sites to be unbound would lead to a rule that could never be applied
  because the cis bindings are required for the connectivity of the result complex.
  -->
  <multi:intraSpeciesReaction id="rc_Intra_Complex_Trans_dissociation"
  name="Intra-Complex_Trans_dissociation"
  reversible="false" fast="false" compartment="inter_membrane" >
    <listOfReactants>
      <speciesReference species="sp_Ecad_trans_dimer_2" constant="false" />
    </listOfReactants>
    <listOfProducts>
      <speciesReference id="Intra_Complex_Trans_dissociation_p1" species="sp_Ecad_7"
      compartmentReference="m1" constant="false" />
      <speciesReference id="Intra_Complex_Trans_dissociation_p2" species="sp_Ecad_7"
      compartmentReference="m2" constant="false" />
    </listOfProducts>
    <kineticLaw>
      <math xmlns="http://www.w3.org/1998/Math/MathML">
        <apply>
          <times />
          <ci> koff </ci>
          <ci> sp_Ecad_7 </ci>
        </apply>
      </math>
      <listOfLocalParameters>
        <localParameter id="koff" value="0.01" units="per_sec" />
      </listOfLocalParameters>
    </kineticLaw>
  </multi:intraSpeciesReaction>
</listOfReactions>
</model>
</sbml>

```

4.3 The “microtubule” example in the previous Multi proposal (2010)

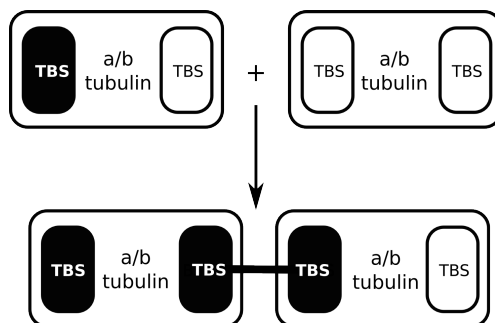

Figure 19: The figure 3.2 in the previous Multi proposal [Novère and Oellrich (2010)]: “A microtubule of undefined length can be extended through a polymerization”

This example is from the previous Multi proposal [Novère and Oellrich (2010)] and Figure 19 is the figure 3.2 in the

previous Multi proposal (2010). An empty “TBS” icon represents an “unbound” binding site and a “TBS” icon filled with black represents a “bound” binding site. The example can be transformed into the SBML Level 3 format with use of the Multi package described in this specification as follows:

```

<?xml version="1.0" encoding="UTF-8"?>
<sbml xmlns="http://www.sbml.org/sbml/level3/version1/core" level="3" version="1"
  xmlns:multi="http://www.sbml.org/sbml/level3/version1/multi/version1" multi:required="true">
  <model name="microtubule_elongation">
    <!-- Compartment -->
    <listOfCompartments>
      <compartment id="cell" constant="true" size="1" multi:isType="false" />
    </listOfCompartments>

    <!-- SpeciesType -->
    <multi:listOfSpeciesTypes>

      <!-- TBS: tubulin binding site -->
      <multi:bindingSiteSpeciesType multi:id="st_tbs" />

      <!-- Tubulin -->
      <multi:speciesType multi:id="st_tubulin">
        <multi:listOfSpeciesTypeInstances>
          <multi:component multi:id="tbs" multi:speciesType="st_tbs" multi:occur="2" />
        </multi:listOfSpeciesTypeInstances>
        <multi:listOfSpeciesTypeComponentIndexes>
          <multi:speciesTypeComponentIndex multi:id="b1"
            multi:component="tbs" multi:occur="1" />
          <multi:speciesTypeComponentIndex multi:id="b2"
            multi:component="tbs" multi:occur="1" />
        </multi:listOfSpeciesTypeComponentIndexes>
      </multi:speciesType>

      <!-- Microtubule -->
      <multi:speciesType multi:id="st_microtubule">
        <multi:listOfSpeciesTypeInstances>
          <multi:component multi:id="tubulin" multi:speciesType="st_tubulin"
            multi:occur="2" />
        </multi:listOfSpeciesTypeInstances>
        <multi:listOfSpeciesTypeComponentIndexes>
          <multi:speciesTypeComponentIndex multi:id="tubulin1"
            multi:component="tubulin" multi:occur="1" />
          <multi:speciesTypeComponentIndex multi:id="tubulin2"
            multi:component="tubulin" multi:occur="1" />
          <multi:speciesTypeComponentIndex multi:id="t1b1"
            multi:component="tbs" multi:identifyingParent="tubulin1" multi:occur="1" />
          <multi:speciesTypeComponentIndex multi:id="t1b2"
            multi:component="tbs" multi:identifyingParent="tubulin1" multi:occur="1" />
          <multi:speciesTypeComponentIndex multi:id="t2b1"
            multi:component="tbs" multi:identifyingParent="tubulin2" multi:occur="1" />
          <multi:speciesTypeComponentIndex multi:id="t2b2"
            multi:component="tbs" multi:identifyingParent="tubulin2" multi:occur="1" />
        </multi:listOfSpeciesTypeComponentIndexes>
        <multi:listOfInSpeciesTypeBonds>
          <multi:inSpeciesTypeBond multi:bindingSite1="t1b2"
            multi:bindingSite2="t2b1" />
        </multi:listOfInSpeciesTypeBonds>
      </multi:speciesType>
    </multi:listOfSpeciesTypes>

    <!-- Species -->
    <listOfSpecies>

      <!-- Fully defined free tubulin species -->
      <species id="sp_free_tubulin" name="free_tubulin" multi:speciesType="st_tubulin"
        compartment="cell" hasOnlySubstanceUnits="false" boundaryCondition="false"

```

```

constant="false" initialAmount="100">
<multi:listOfOutwardBindingSites>
  <multi:outwardBindingSite multi:component="b1"
    multi:bindingStatus="unbound" />
  <multi:outwardBindingSite multi:component="b2"
    multi:bindingStatus="unbound" />
</multi:listOfOutwardBindingSites>
</species>

<!-- Fully defined free microtubule species: 2 tubulin bound together -->
<species id="sp_microtubule_free" name="microtubule_free" multi:speciesType="st_microtubule"
  compartment="cell" hasOnlySubstanceUnits="false" boundaryCondition="false"
  constant="false" initialAmount="200">
<multi:listOfOutwardBindingSites>
  <multi:outwardBindingSite multi:component="t1b1"
    multi:bindingStatus="unbound" />
  <multi:outwardBindingSite multi:component="t2b2"
    multi:bindingStatus="unbound" />
</multi:listOfOutwardBindingSites>
</species>

<!-- Pattern tubulin species: one binding site is free and another binding site is
dont care -->
<species id="sp_tubulin_pattern" name="tubulin_pattern" multi:speciesType="st_tubulin"
  compartment="cell" hasOnlySubstanceUnits="false" boundaryCondition="false"
  constant="false">
<multi:listOfOutwardBindingSites>
  <!-- b1: dont care -->
  <multi:outwardBindingSite multi:component="b2"
    multi:bindingStatus="unbound" />
</multi:listOfOutwardBindingSites>
</species>

<!-- Pattern microtubule species: 2 tubulin bound together, one end is free and another
end is dont care -->
<species id="sp_microtubule_pattern" name="microtubule_pattern"
  multi:speciesType="st_microtubule" compartment="cell" hasOnlySubstanceUnits="false"
  boundaryCondition="false" constant="false">
<multi:listOfOutwardBindingSites>
  <multi:outwardBindingSite multi:component="t2b2"
    multi:bindingStatus="unbound" />
</multi:listOfOutwardBindingSites>
</species>
</listOfSpecies>

<!-- Reaction -->
<listOfReactions>

<!-- Pattern tubulin elongated with a free tubulin -->
<reaction id="tubulin_binding" reversible="false" fast="false">
  <listOfReactants>
    <speciesReference species="sp_free_tubulin" constant="false" />
    <speciesReference species="sp_tubulin_pattern" constant="false" />
  </listOfReactants>
  <listOfProducts>
    <speciesReference species="sp_microtubule_pattern" constant="false">
      <multi:listSpeciesTypeComponentMapsInProduct>
        <multi:speciesComponentMapInProduct
          multi:reactantComponent="b1" multi:reactant="sp_tubulin_pattern"
          multi:productComponent="t1b1" />
        <multi:speciesComponentMapInProduct
          multi:reactantComponent="b2" multi:reactant="sp_tubulin_pattern"
          multi:productComponent="t1b2" />
        <multi:speciesComponentMapInProduct
          multi:reactantComponent="b1" multi:reactant="sp_free_tubulin"
          multi:productComponent="t2b1" />
      </multi:listSpeciesTypeComponentMapsInProduct>
    </speciesReference>
  </listOfProducts>
</reaction>

```

```

      <multi:speciesComponentMapInProduct
        multi:reactantComponent="b2" multi:reactant="sp_free_tubulin"
        multi:productComponent="t2b2" />
    </multi:listSpeciesTypeComponentMapsInProduct>
  </speciesReference>
</listOfProducts>
<kineticLaw>
  <math xmlns="http://www.w3.org/1998/Math/MathML">
    <apply>
      <times />
      <ci>cell</ci>
      <ci>kon</ci>
      <ci>sp_free_tubulin</ci>
      <ci>sp_tubulin_pattern</ci>
    </apply>
  </math>
  <listOfLocalParameters>
    <localParameter id="kon" value="1" />
  </listOfLocalParameters>
</kineticLaw>
</reaction>
</listOfReactions>
</model>
</sbml>

```

4.4 A BioNetGen example from its user manual

egfr_simple.bngl (http://bionetgen.org/index.php/BNGManual:Listing_1)

```

begin parameters
  NA 6.02e23          # Avogadro's number (molecules/mol)
  f 1                 # Fraction of the cell to simulate
  Vo f*1.0e-10       # Extracellular volume=1/cell_density (L)
  V f*3.0e-12        # Cytoplasmic volume (L)

  EGF_init 20*1e-9*NA*Vo  # Initial amount of ligand (20 nM)
                          # converted to copies per cell

  # Initial amounts of cellular components (copies per cell)
  EGFR_init f*1.8e5
  Grb2_init f*1.5e5
  Sos1_init f*6.2e4

  # Rate constants
  # Divide by NA*V to convert bimolecular rate constants
  # from /M/sec to /(molecule/cell)/sec
  kp1 9.0e7/(NA*Vo)  # ligand-monomer binding
  km1 0.06           # ligand-monomer dissociation
  kp2 1.0e7/(NA*V)  # aggregation of bound monomers
  km2 0.1            # dissociation of bound monomers
  kp3 0.5           # dimer transphosphorylation
  km3 4.505         # dimer dephosphorylation
  kp4 1.5e6/(NA*V)  # binding of Grb2 to receptor
  km4 0.05          # dissociation of Grb2 from receptor
  kp5 1.0e7/(NA*V)  # binding of Grb2 to Sos1
  km5 0.06          # dissociation of Grb2 from Sos1
  deg 0.01          # degradation of receptor dimers
end parameters

begin molecule types
  EGF(R)
  EGFR(L,CR1,Y1068~U~P)
  Grb2(SH2,SH3)
  Sos1(PxxP)

```

```

Trash()
end molecule types

begin seed species
EGF(R)          0
EGFR(L,CR1,Y1068~U) EGFR_init
Grb2(SH2,SH3)   Grb2_init
Sos1(PxxP)      Sos1_init
end seed species

begin observables
1 Molecules EGFR_tot EGFR()
2 Molecules Lig_free EGF(R)
3 Species Dim EGFR(CR1!+)
4 Molecules RP EGFR(Y1068~P!?)
5 Molecules Grb2Sos1 Grb2(SH2,SH3!1).Sos1(PxxP!1)
6 Molecules Sos1_act EGFR(Y1068!1).Grb2(SH2!1,SH3!2).Sos1(PxxP!2)
end observables

begin reaction rules
# Ligand-receptor binding
1 EGFR(L,CR1) + EGF(R) <-> EGFR(L!1,CR1).EGF(R!1) kp1, km1

# Receptor-aggregation
2 EGFR(L!+,CR1) + EGFR(L!+,CR1) <-> EGFR(L!+,CR1!1).EGFR(L!+,CR1!1) kp2,km2

# Transphosphorylation of EGFR by RTK
3 EGFR(CR1!+,Y1068~U) -> EGFR(CR1!+,Y1068~P) kp3

# Dephosphorylation
4 EGFR(Y1068~P) -> EGFR(Y1068~U) km3

# Grb2 binding to pY1068
5 EGFR(Y1068~P) + Grb2(SH2) <-> EGFR(Y1068~P!1).Grb2(SH2!1) kp4,km4

# Grb2 binding to Sos1
6 Grb2(SH3) + Sos1(PxxP) <-> Grb2(SH3!1).Sos1(PxxP!1) kp5,km5

# Receptor dimer internalization/degradation
7 EGF(R!1).EGF(R!2).EGFR(L!1,CR1!3).EGFR(L!2,CR1!3) -> Trash()
end reaction rules

#actions
generate_network({overwrite=>1});

# Equilibration
simulate_ode({suffix=>equil,t_end=>100000,n_steps=>10,sparse=>1,steady_state=>1});
setConcentration("EGF(R)","EGF_init");
saveConcentrations(); # Saves concentrations for future reset

# Kinetics
writeSBML({});
simulate_ode({t_end=>120,n_steps=>120});
resetConcentrations(); # reverts to saved Concentrations
simulate_ssa({suffix=>ssa,t_end=>120,n_steps=>120});

```

The SBML code can be as follows. Please note, the SBML code does not cover the content other than the model in the bngl file, such as the “actions”, “Equilibration” and “Kinetics” sections.

```

<?xml version="1.0" encoding="UTF-8"?>
<sbml xmlns="http://www.sbml.org/sbml/level3/version1/core" level="3" version="1"
  xmlns:multi="http://www.sbml.org/sbml/level3/version1/multi/version1" multi:required="true">
  <model name="bionetgen_example_egfr_simple">

```

```

<listOfUnitDefinitions>
  <unitDefinition id="molecules_per_mol">
    <listOfUnits>
      <unit kind="mole" scale="0" multiplier="1" exponent="-1" />
    </listOfUnits>
  </unitDefinition>
</listOfUnitDefinitions>

<!-- compartments -->
<listOfCompartments>
  <compartment id="Vo" constant="true" spatialDimensions="3" units="liter"
    multi:isType="false" />
  <compartment id="V" constant="true" spatialDimensions="3" units="liter"
    multi:isType="false" />
</listOfCompartments>

<!-- speciesType -->
<multi:listOfSpeciesTypes>

  <!-- EGF(R) -->
  <multi:bindingSiteSpeciesType multi:id="st_EGF_bs_R" />
  <multi:speciesType multi:id="st_EGF">
    <multi:listOfSpeciesTypeInstances>
      <multi:component multi:id="R" multi:speciesType="st_EGF_bs_R" multi:occur="1" />
    </multi:listOfSpeciesTypeInstances>
  </multi:speciesType>

  <!-- EGFR(L,CR1,Y1068~U~P) -->
  <multi:bindingSiteSpeciesType multi:id="st_EGFR_bs_L" />
  <multi:bindingSiteSpeciesType multi:id="st_EGFR_bs_CR1" />
  <multi:bindingSiteSpeciesType multi:id="st_EGFR_bs_Y1068">
    <multi:listOfSpeciesFeatureTypes>
      <multi:speciesFeatureType multi:id="sft_Y1068">
        <multi:listOfPossibleSpeciesFeatureValues>
          <multi:possibleSpeciesFeatureValue multi:id="U" />
          <multi:possibleSpeciesFeatureValue multi:id="P" />
        </multi:listOfPossibleSpeciesFeatureValues>
      </multi:speciesFeatureType>
    </multi:listOfSpeciesFeatureTypes>
  </multi:bindingSiteSpeciesType>
  <multi:speciesType multi:id="st_EGFR">
    <multi:listOfSpeciesTypeInstances>
      <multi:component multi:id="L" multi:speciesType="st_EGFR_bs_L" multi:occur="1" />
      <multi:component multi:id="CR1" multi:speciesType="st_EGFR_bs_CR1" multi:occur="1" />
      <multi:component multi:id="Y1068" multi:speciesType="st_EGFR_bs_Y1068"
        multi:occur="1" />
    </multi:listOfSpeciesTypeInstances>
  </multi:speciesType>

  <!-- EGFR dimer: [EGFR(CR1!1).EGFR(CR1!1)] -->
  <multi:speciesType multi:id="st_EGFR_dimer">
    <multi:listOfSpeciesTypeInstances>
      <multi:component multi:id="EGFR" multi:speciesType="st_EGFR" multi:occur="2" />
    </multi:listOfSpeciesTypeInstances>
    <multi:listOfSpeciesTypeComponentIndexes>
      <multi:speciesTypeComponentIndex multi:id="EGFR1"
        multi:component="EGFR" multi:occur="1" />
      <multi:speciesTypeComponentIndex multi:id="EGFR2"
        multi:component="EGFR" multi:occur="1" />
      <multi:speciesTypeComponentIndex multi:id="EGFR1CR1"
        multi:component="CR1" identifyingParent="EGFR1" multi:occur="1" />
      <multi:speciesTypeComponentIndex multi:id="EGFR2CR1"
        multi:component="CR1" identifyingParent="EGFR2" multi:occur="1" />
    </multi:listOfSpeciesTypeComponentIndexes>
    <multi:listOfInSpeciesTypeBonds>
      <multi:inSpeciesTypeBond multi:bindingSite1="EGFR1CR1"

```

8
9
10
11
12
13
14
15
16
17
18
19
20
21
22
23
24
25
26
27
28
29
30
31
32
33
34
35
36
37
38
39
40
41
42
43
44
45
46
47
48
49
50
51
52
53
54
55
56
57
58
59
60
61
62
63
64
65
66
1
2
3
4
5
6
7

```

        multi:bindingSite2="EGFR2CR1" />
    </multi:listOfInSpeciesTypeBonds>
</multi:speciesType>

<!-- EGFR-EGF dimer: [EGF(R!1).EGF(R!2).EGFR(L!1,CR1!3).EGFR(L!2,CR1!3)] -->
<multi:speciesType multi:id="st_EGFR_EGF_dimer">
    <multi:listOfSpeciesTypeInstances>
        <multi:component multi:id="EGF" multi:speciesType="st_EGF" multi:occur="2" />
        <multi:component multi:id="EGFR" multi:speciesType="st_EGFR" multi:occur="2" />
    </multi:listOfSpeciesTypeInstances>
    <multi:listOfSpeciesTypeComponentIndexes>
        <multi:speciesTypeComponentIndex multi:id="EGFR1"
            multi:component="EGFR" multi:occur="1" />
        <multi:speciesTypeComponentIndex multi:id="EGFR2"
            multi:component="EGFR" multi:occur="1" />
        <multi:speciesTypeComponentIndex multi:id="EGF1"
            multi:component="EGF" multi:occur="1" />
        <multi:speciesTypeComponentIndex multi:id="EGF2"
            multi:component="EGF" multi:occur="1" />
        <multi:speciesTypeComponentIndex multi:id="EGF1R"
            multi:component="R" identifyingParent="EGF1" multi:occur="1" />
        <multi:speciesTypeComponentIndex multi:id="EGF2R"
            multi:component="R" identifyingParent="EGF2" multi:occur="1" />
        <multi:speciesTypeComponentIndex multi:id="EGFR1L"
            multi:component="L" identifyingParent="EGFR1" multi:occur="1" />
        <multi:speciesTypeComponentIndex multi:id="EGFR2L"
            multi:component="L" identifyingParent="EGFR2" multi:occur="1" />
        <multi:speciesTypeComponentIndex multi:id="EGFR1CR1"
            multi:component="CR1" identifyingParent="EGFR1" multi:occur="1" />
        <multi:speciesTypeComponentIndex multi:id="EGFR2CR1"
            multi:component="CR1" identifyingParent="EGFR2" multi:occur="1" />
    </multi:listOfSpeciesTypeComponentIndexes>
    <multi:listOfInSpeciesTypeBonds>
        <multi:inSpeciesTypeBond multi:bindingSite1="EGFR1CR1" multi:bindingSite2="EGFR2CR1" />
        <multi:inSpeciesTypeBond multi:bindingSite1="EGF1R" multi:bindingSite2="EGFR1L" />
        <multi:inSpeciesTypeBond multi:bindingSite1="EGF2R" multi:bindingSite2="EGFR2L" />
    </multi:listOfInSpeciesTypeBonds>
</multi:speciesType>

<!-- Grb2(SH2, SH3) -->
<multi:bindingSiteSpeciesType multi:id="st_Grb2_bs_SH2" />
<multi:bindingSiteSpeciesType multi:id="st_Grb2_bs_SH3" />
<multi:speciesType multi:id="st_Grb2">
    <multi:listOfSpeciesTypeInstances>
        <multi:component multi:id="SH2" multi:speciesType="st_Grb2_bs_SH2" multi:occur="1" />
        <multi:component multi:id="SH3" multi:speciesType="st_Grb2_bs_SH3" multi:occur="1" />
    </multi:listOfSpeciesTypeInstances>
</multi:speciesType>

<!-- Sos1 -->
<multi:bindingSiteSpeciesType multi:id="st_Sos1_bs_PxxP" />
<multi:speciesType multi:id="st_Sos1">
    <multi:listOfSpeciesTypeInstances>
        <multi:component multi:id="PxxP" multi:speciesType="st_Sos1_bs_PxxP"
            multi:occur="1" />
    </multi:listOfSpeciesTypeInstances>
</multi:speciesType>

<!-- Trash -->
<multi:speciesType multi:id="trash" />

<!-- Grb2-Sos1 -->
<multi:speciesType multi:id="st_Grb2_Sos1">
    <multi:listOfSpeciesTypeInstances>
        <multi:component multi:id="Grb2" multi:speciesType="st_Grb2" multi:occur="1" />
        <multi:component multi:id="Sos1" multi:speciesType="st_Sos1" multi:occur="1" />
    </multi:listOfSpeciesTypeInstances>
</multi:speciesType>

```

```

</multi:listOfSpeciesTypeInstances>
<multi:listOfInSpeciesTypeBonds>
  <multi:inSpeciesTypeBond multi:bindingSite1="SH3" multi:bindingSite2="PxxP" />
</multi:listOfInSpeciesTypeBonds>
</multi:speciesType>

<!-- EGFR(Y1068!1).Grb1(SH2!1,SH3!2).Sos1(PxxP!2) -->
<multi:speciesType multi:id="st_EGFR_Grb2_Sos1">
  <multi:listOfSpeciesTypeInstances>
    <multi:component multi:id="EGFR" multi:speciesType="st_EGFR" multi:occur="1" />
    <multi:component multi:id="Grb2" multi:speciesType="st_Grb2" multi:occur="1" />
    <multi:component multi:id="Sos1" multi:speciesType="st_Sos1" multi:occur="1" />
  </multi:listOfSpeciesTypeInstances>
  <multi:listOfInSpeciesTypeBonds>
    <multi:inSpeciesTypeBond multi:bindingSite1="Y1068" multi:bindingSite2="SH2" />
    <multi:inSpeciesTypeBond multi:bindingSite1="SH3" multi:bindingSite2="PxxP" />
  </multi:listOfInSpeciesTypeBonds>
</multi:speciesType>

<!-- EGFR(L!1).EGF(R!1) -->
<multi:speciesType multi:id="st_EGFR_EGF">
  <multi:listOfSpeciesTypeInstances>
    <multi:component multi:id="EGFR" multi:speciesType="st_EGFR" multi:occur="1" />
    <multi:component multi:id="EGF" multi:speciesType="st_EGF" multi:occur="1" />
  </multi:listOfSpeciesTypeInstances>
  <multi:listOfInSpeciesTypeBonds>
    <multi:inSpeciesTypeBond multi:bindingSite1="L" multi:bindingSite2="R" />
  </multi:listOfInSpeciesTypeBonds>
</multi:speciesType>

<!-- EGFR(Y1068!1).Grb2(SH2!1) -->
<multi:speciesType multi:id="st_EGFR_Grb2">
  <multi:listOfSpeciesTypeInstances>
    <multi:component multi:id="EGFR" multi:speciesType="st_EGFR" multi:occur="1" />
    <multi:component multi:id="Grb2" multi:speciesType="st_Grb2" multi:occur="1" />
  </multi:listOfSpeciesTypeInstances>
  <multi:listOfInSpeciesTypeBonds>
    <multi:inSpeciesTypeBond multi:bindingSite1="Y1068" multi:bindingSite2="SH2" />
  </multi:listOfInSpeciesTypeBonds>
</multi:speciesType>

</multi:listOfSpeciesTypes>

<!-- species -->
<listOfSpecies>

  <species id="sp_EGF_free" name="EGF(R)" multi:speciesType="st_EGF"
    hasOnlySubstanceUnits="false"
    boundaryCondition="false" constant="false">
    <multi:listOfOutwardBindingSites>
      <multi:outwardBindingSite multi:component="R" multi:bindingStatus="unbound" />
    </multi:listOfOutwardBindingSites>
  </species>

  <species id="sp_EGFR_free_U" name="EGFR(L,CR1,Y1068~U)" multi:speciesType="st_EGFR"
    hasOnlySubstanceUnits="false" boundaryCondition="false" constant="false">
    <multi:listOfOutwardBindingSites>
      <multi:outwardBindingSite multi:component="L" multi:bindingStatus="unbound" />
      <multi:outwardBindingSite multi:component="CR1" multi:bindingStatus="unbound" />
      <multi:outwardBindingSite multi:component="Y1068" multi:bindingStatus="unbound" />
    </multi:listOfOutwardBindingSites>
    <multi:listOfSpeciesFeatures>
      <multi:speciesFeature multi:speciesFeatureType="sft_Y1068">
        <multi:listOfSpeciesFeatureValues>
          <multi:speciesFeatureValue multi:value="U" />
        </multi:listOfSpeciesFeatureValues>
      </multi:speciesFeature>
    </multi:listOfSpeciesFeatures>
  </species>

```

```

      </multi:speciesFeature>
    </multi:listOfSpeciesFeatures>
  </species>
  <species id="sp_Grb2_free" name="Grb2(SH2,SH3)" multi:speciesType="st_Grb2"
    hasOnlySubstanceUnits="false" boundaryCondition="false" constant="false">
    <multi:listOfOutwardBindingSites>
      <multi:outwardBindingSite multi:component="SH2" multi:bindingStatus="unbound" />
      <multi:outwardBindingSite multi:component="SH3" multi:bindingStatus="unbound" />
    </multi:listOfOutwardBindingSites>
  </species>
  <species id="sp_Grb2_SH2" name="Grb2(SH2)" multi:speciesType="st_Grb2"
    hasOnlySubstanceUnits="false"
    boundaryCondition="false" constant="false">
    <multi:listOfOutwardBindingSites>
      <multi:outwardBindingSite multi:component="SH2" multi:bindingStatus="unbound" />
    </multi:listOfOutwardBindingSites>
  </species>
  <species id="sp_Grb2_SH3" name="Grb2(SH3)" multi:speciesType="st_Grb2"
    hasOnlySubstanceUnits="false"
    boundaryCondition="false" constant="false">
    <multi:listOfOutwardBindingSites>
      <multi:outwardBindingSite multi:component="SH3" multi:bindingStatus="unbound" />
    </multi:listOfOutwardBindingSites>
  </species>
  <species id="sp_Sos1_free" name="Sos1(PxxP)" multi:speciesType="st_Sos1"
    hasOnlySubstanceUnits="false" boundaryCondition="false" constant="false">
    <multi:listOfOutwardBindingSites>
      <multi:outwardBindingSite multi:component="PxxP" multi:bindingStatus="unbound" />
    </multi:listOfOutwardBindingSites>
  </species>
  <species id="sp_EGF_tot" name="EGF()" multi:speciesType="st_EGF"
    hasOnlySubstanceUnits="false"
    boundaryCondition="false" constant="false" />
  <species id="sp_EGFR_dimerized" name="EGFR(CR1!+)" multi:speciesType="st_EGFR"
    hasOnlySubstanceUnits="false" boundaryCondition="false" constant="false">
    <multi:listOfOutwardBindingSites>
      <multi:outwardBindingSite multi:component="CR1" multi:bindingStatus="bound" />
    </multi:listOfOutwardBindingSites>
  </species>
  <species id="sp_EGFR_U" name="EGFR(Y1068~P!?)" multi:speciesType="st_EGFR"
    hasOnlySubstanceUnits="false" boundaryCondition="false" constant="false">
    <multi:listOfSpeciesFeatures>
      <multi:speciesFeature multi:speciesFeatureType="sft_Y1068">
        <multi:listOfSpeciesFeatureValues>
          <multi:speciesFeatureValue multi:value="P" />
        </multi:listOfSpeciesFeatureValues>
      </multi:speciesFeature>
    </multi:listOfSpeciesFeatures>
  </species>
  <species id="sp_EGFR_L_CR1" name="EGFR(L,CR1)" multi:speciesType="st_EGFR"
    hasOnlySubstanceUnits="false" boundaryCondition="false" constant="false">
    <multi:listOfOutwardBindingSites>
      <multi:outwardBindingSite multi:component="L" multi:bindingStatus="unbound" />
      <multi:outwardBindingSite multi:component="CR1" multi:bindingStatus="unbound" />
    </multi:listOfOutwardBindingSites>
  </species>
  <species id="sp_EGFR_EGF_CR1" name="EGFR(L!1,CR1).EGF(R!1)" multi:speciesType="st_EGFR_EGF"
    hasOnlySubstanceUnits="false" boundaryCondition="false" constant="false">
    <multi:listOfOutwardBindingSites>
      <multi:outwardBindingSite multi:component="CR1" multi:bindingStatus="unbound" />
    </multi:listOfOutwardBindingSites>
  </species>
  <species id="sp_EGFR_bL_CR1" name="EGFR(L!+,CR1)" multi:speciesType="st_EGFR"
    hasOnlySubstanceUnits="false" boundaryCondition="false" constant="false">
    <multi:listOfOutwardBindingSites>
      <multi:outwardBindingSite multi:component="L" multi:bindingStatus="bound" />
    </multi:listOfOutwardBindingSites>
  </species>

```

```

      <multi:outwardBindingSite multi:component="CR1" multi:bindingStatus="unbound" />
    </multi:listOfOutwardBindingSites>
  </species>
  <species id="sp_EGFR_dimer_bl" name="EGFR(L!+,CR1!1).EGFR(L!+,CR1!1)"
    multi:speciesType="st_EGFR_dimer"
    hasOnlySubstanceUnits="false" boundaryCondition="false" constant="false">
    <multi:listOfOutwardBindingSites>
      <multi:outwardBindingSite multi:component="EGFR1L"
        multi:bindingStatus="bound" />
      <multi:outwardBindingSite multi:component="EGFR2L"
        multi:bindingStatus="bound" />
    </multi:listOfOutwardBindingSites>
  </species>
  <species id="sp_EGFR_EGF_dimer" name="EGF(R!1).EGF(R!2).EGFR(L!1,CR1!3).EGFR(L!2,CR1!3)"
    multi:speciesType="st_EGFR_EGF_dimer" hasOnlySubstanceUnits="false"
    boundaryCondition="false"
    constant="false" />
  <species id="sp_EGFR_bCR1_Y1068_U" name="EGFR(CR1!+,Y1068~U)" multi:speciesType="st_EGFR"
    hasOnlySubstanceUnits="false" boundaryCondition="false" constant="false">
    <multi:listOfOutwardBindingSites>
      <multi:outwardBindingSite multi:component="CR1" multi:bindingStatus="bound" />
      <multi:outwardBindingSite multi:component="Y1068" multi:bindingStatus="unbound" />
    </multi:listOfOutwardBindingSites>
    <multi:listOfSpeciesFeatures>
      <multi:speciesFeature multi:speciesFeatureType="sft_Y1068">
        <multi:listOfSpeciesFeatureValues>
          <multi:speciesFeatureValue multi:value="U" />
        </multi:listOfSpeciesFeatureValues>
      </multi:speciesFeature>
    </multi:listOfSpeciesFeatures>
  </species>
  <species id="sp_EGFR_bCR1_Y1068_P" name="EGFR(CR1!+,Y1068~P)" multi:speciesType="st_EGFR"
    hasOnlySubstanceUnits="false" boundaryCondition="false" constant="false">
    <multi:listOfOutwardBindingSites>
      <multi:outwardBindingSite multi:component="CR1" multi:bindingStatus="bound" />
      <multi:outwardBindingSite multi:component="Y1068" multi:bindingStatus="unbound" />
    </multi:listOfOutwardBindingSites>
    <multi:listOfSpeciesFeatures>
      <multi:speciesFeature multi:speciesFeatureType="sft_Y1068">
        <multi:listOfSpeciesFeatureValues>
          <multi:speciesFeatureValue multi:value="P" />
        </multi:listOfSpeciesFeatureValues>
      </multi:speciesFeature>
    </multi:listOfSpeciesFeatures>
  </species>
  <species id="sp_EGFR_Y1068_P" name="EGFR(Y1068~P)" multi:speciesType="st_EGFR"
    hasOnlySubstanceUnits="false" boundaryCondition="false" constant="false">
    <multi:listOfOutwardBindingSites>
      <multi:outwardBindingSite multi:component="Y1068" multi:bindingStatus="unbound" />
    </multi:listOfOutwardBindingSites>
    <multi:listOfSpeciesFeatures>
      <multi:speciesFeature multi:speciesFeatureType="sft_Y1068">
        <multi:listOfSpeciesFeatureValues>
          <multi:speciesFeatureValue multi:value="P" />
        </multi:listOfSpeciesFeatureValues>
      </multi:speciesFeature>
    </multi:listOfSpeciesFeatures>
  </species>
  <species id="sp_EGFR_Y1068_U" name="EGFR(Y1068~U)" multi:speciesType="st_EGFR"
    hasOnlySubstanceUnits="false" boundaryCondition="false" constant="false">
    <multi:listOfOutwardBindingSites>
      <multi:outwardBindingSite multi:component="Y1068" multi:bindingStatus="unbound" />
    </multi:listOfOutwardBindingSites>
    <multi:listOfSpeciesFeatures>
      <multi:speciesFeature multi:speciesFeatureType="sft_Y1068">
        <multi:listOfSpeciesFeatureValues>

```

```

        <multi:speciesFeatureValue multi:value="U" />
      </multi:listOfSpeciesFeatureValues>
    </multi:speciesFeature>
  </multi:listOfSpeciesFeatures>
</species>
<species id="sp_EGFR_Grb2_P" name="EGFR(Y1068~P!1).Grb2(SH2!1)"
  multi:speciesType="st_EGFR_Grb2"
  hasOnlySubstanceUnits="false" boundaryCondition="false" constant="false">
  <multi:listOfSpeciesFeatures>
    <multi:speciesFeature multi:speciesFeatureType="sft_Y1068">
      <multi:listOfSpeciesFeatureValues>
        <multi:speciesFeatureValue multi:value="P" />
      </multi:listOfSpeciesFeatureValues>
    </multi:speciesFeature>
  </multi:listOfSpeciesFeatures>
</species>
<species id="sp_Grb2_Sos1" name="Grb2(SH3!1).Sos1(PxxP!1)" multi:speciesType="st_Grb2_Sos1"
  hasOnlySubstanceUnits="false" boundaryCondition="false" constant="false" />

<species id="sp_Trash" name="Trash()" multi:speciesType="st_Trash"
  hasOnlySubstanceUnits="false"
  boundaryCondition="false" constant="false" />
</listOfSpecies>

<!-- parameters -->
<listOfParameters>
  <parameter id="NA" value="6.02e23" constant="true" units="molecules_per_mol" />
  <parameter id="f" value="1" constant="true" />
  <parameter id="kp1" constant="true" />
  <parameter id="km1" value="0.06" constant="true" />
  <parameter id="kp2" constant="true" />
  <parameter id="km2" value="0.1" constant="true" />
  <parameter id="kp3" value="0.5" constant="true" />
  <parameter id="km3" value="4.505" constant="true" />
  <parameter id="kp4" constant="true" />
  <parameter id="km4" value="0.05" constant="true" />
  <parameter id="kp5" constant="true" />
  <parameter id="km5" value="0.06" constant="true" />
  <parameter id="deg" value="0.01" constant="true" />
</listOfParameters>

<!-- intialAssignments -->
<listOfIntialAssignments>

  <initialAssignment symbol="Vo">
    <math xmlns="http://www.w3.org/1998/Math/MathML">
      <apply>
        <times />
        <ci>f</ci>
        <cn> 1e-10 </cn>
      </apply>
    </math>
  </initialAssignment>
  <initialAssignment symbol="V">
    <math xmlns="http://www.w3.org/1998/Math/MathML">
      <apply>
        <times />
        <ci>f</ci>
        <cn> 3e-12 </cn>
      </apply>
    </math>
  </initialAssignment>
  <initialAssignment symbol="kp1">
    <math xmlns="http://www.w3.org/1998/Math/MathML">
      <apply>
        <divide />

```

```

        <cn>9.02e7</cn>
        <apply>
          <times />
          <ci>NA</ci>
          <ci>Vo</ci>
        </apply>
      </math>
</initialAssignment>
<initialAssignment symbol="kp2">
  <math xmlns="http://www.w3.org/1998/Math/MathML">
    <apply>
      <divide />
      <cn>1.0e7</cn>
      <apply>
        <times />
        <ci>NA</ci>
        <ci>V</ci>
      </apply>
    </apply>
  </math>
</initialAssignment>
<initialAssignment symbol="kp4">
  <math xmlns="http://www.w3.org/1998/Math/MathML">
    <apply>
      <divide />
      <cn>1.5e6</cn>
      <apply>
        <times />
        <ci>NA</ci>
        <ci>V</ci>
      </apply>
    </apply>
  </math>
</initialAssignment>
<initialAssignment symbol="kp5">
  <math xmlns="http://www.w3.org/1998/Math/MathML">
    <apply>
      <divide />
      <cn>1.0e7</cn>
      <apply>
        <times />
        <ci>NA</ci>
        <ci>V</ci>
      </apply>
    </apply>
  </math>
</initialAssignment>
<initialAssignment symbol="sp_EGF_free">
  <math xmlns="http://www.w3.org/1998/Math/MathML">
    <apply>
      <times />
      <cn>20</cn>
      <cn>1e-9</cn>
      <ci>NA</ci>
      <ci>Vo</ci>
    </apply>
  </math>
</initialAssignment>
<initialAssignment symbol="sp_EGFR_free_U">
  <math xmlns="http://www.w3.org/1998/Math/MathML">
    <apply>
      <times />
      <ci>f</ci>
      <cn>1.8e5</cn>
    </apply>
  </math>

```

8
9
10
11
12
13
14
15
16
17
18
19
20
21
22
23
24
25
26
27
28
29
30
31
32
33
34
35
36
37
38
39
40
41
42
43
44
45
46
47
48
49
50
51
52
53
54
55
56
57
58
59
60
61
62
63
64
65
66
1
2
3
4
5
6
7

```

</math>
</initialAssignment>
<initialAssignment symbol="sp_Grb2_free">
  <math xmlns="http://www.w3.org/1998/Math/MathML">
    <apply>
      <times />
      <ci>f</ci>
      <cn>1.5e5</cn>
    </apply>
  </math>
</initialAssignment>
<initialAssignment symbol="sp_Sos1_free">
  <math xmlns="http://www.w3.org/1998/Math/MathML">
    <apply>
      <times />
      <ci>f</ci>
      <cn>6.2e4</cn>
    </apply>
  </math>
</initialAssignment>
</listOfInitialAssignments>

<!-- reactions -->
<listOfReactions>

  <!-- # Ligand-receptor binding -->
  <!-- 1 EGFR(L,CR1) + EGF(R) <-> EGFR(L!1,CR1).EGF(R!1) kp1, km1 -->
  <reaction id="rc_Ligand_receptor_binding" reversible="true" fast="false">
    <listOfReactants>
      <speciesReference species="sp_EGFR_L_CR1" constant="false" />
      <speciesReference species="sp_EGF_free" constant="false" />
    </listOfReactants>
    <listOfProducts>
      <speciesReference species="sp_EGFR_EGF_CR1" constant="false" />
    </listOfProducts>
    <kineticLaw>
      <math xmlns="http://www.w3.org/1998/Math/MathML">
        <apply>
          <minus />
          <apply>
            <times />
            <ci>kp1</ci>
            <ci>sp_EGFR_L_CR1</ci>
            <ci>sp_EGF_free</ci>
          </apply>
          <apply>
            <times />
            <ci>km1</ci>
            <ci>sp_EGFR_EGF_CR1</ci>
          </apply>
        </apply>
      </math>
    </kineticLaw>
  </reaction>

  <!-- # Receptor-aggregation -->
  <!-- 2 EGFR(L!+,CR1) + EGFR(L!+,CR1) <-> EGFR(L!+,CR1!1).EGFR(L!+,CR1!1) kp2,km2 -->
  <reaction id="rc_Receptor_aggregation" reversible="true" fast="false">
    <listOfReactants>
      <speciesReference species="sp_EGFR_bL_CR1" constant="false" stoichiometry="2" />
    </listOfReactants>
    <listOfProducts>
      <speciesReference species="sp_EGFR_dimer_bL" constant="false" />
    </listOfProducts>
    <kineticLaw>
      <math xmlns="http://www.w3.org/1998/Math/MathML">

```

```

      <apply>
        <minus />
        <apply>
          <times />
          <ci> kp2 </ci>
          <ci> sp_EGFR_bL_CR1 </ci>
          <ci> sp_EGFR_bL_CR1 </ci>
        </apply>
      </apply>
    </math>
  </kineticLaw>
</reaction>

<!-- # Transphosphorylation of EGFR by RTK -->
<!-- 3 EGFR(CR1!+,Y1068~U) -> EGFR(CR1!+,Y1068~P) kp3 -->
<reaction id="rc_Transphosphorylation" reversible="false" fast="false">
  <listOfReactants>
    <speciesReference species="sp_EGFR_bCR1_Y1068_U" constant="false" />
  </listOfReactants>
  <listOfProducts>
    <speciesReference species="sp_EGFR_bCR1_Y1068_P" constant="false" />
  </listOfProducts>
  <kineticLaw>
    <math xmlns="http://www.w3.org/1998/Math/MathML">
      <apply>
        <times />
        <ci>kp3</ci>
        <ci>sp_EGFR_bCR1_Y1068_U</ci>
      </apply>
    </math>
  </kineticLaw>
</reaction>

<!-- # Dephosphorylation -->
<!-- 4 EGFR(Y1068~P) -> EGFR(Y1068~U) km3 -->
<reaction id="rc_Dephosphorylation" reversible="false" fast="false">
  <listOfReactants>
    <speciesReference species="sp_EGFR_Y1068_P" constant="false" />
  </listOfReactants>
  <listOfProducts>
    <speciesReference species="sp_EGFR_Y1068_U" constant="false" />
  </listOfProducts>
  <kineticLaw>
    <math xmlns="http://www.w3.org/1998/Math/MathML">
      <apply>
        <times />
        <ci>km3</ci>
        <ci>sp_EGFR_Y1068_P</ci>
      </apply>
    </math>
  </kineticLaw>
</reaction>

<!-- # Grb2 binding to pY1068 -->
<!-- 5 EGFR(Y1068~P) + Grb2(SH2) <-> EGFR(Y1068~P!1).Grb2(SH2!1) kp4,km4 -->
<reaction id="rc_Grb2_binding_to_pY1068" reversible="true" fast="false">
  <listOfReactants>
    <speciesReference species="sp_EGFR_Y1068_P" constant="false" />
    <speciesReference species="sp_Grb2_SH2" constant="false" />
  </listOfReactants>
  <listOfProducts>

```

8
9
10
11
12
13
14
15
16
17
18
19
20
21
22
23
24
25
26
27
28
29
30
31
32
33
34
35
36
37
38
39
40
41
42
43
44
45
46
47
48
49
50
51
52
53
54
55
56
57
58
59
60
61
62
63
64
65
66
1
2
3
4
5
6
7

```

    <speciesReference species="sp_EGFR_Grb2_P" constant="false" />
  </listOfProducts>
  <kineticLaw>
    <math xmlns="http://www.w3.org/1998/Math/MathML">
      <apply>
        <minus />
        <apply>
          <times />
          <ci> kp4 </ci>
          <ci> sp_EGFR_Y1068_P </ci>
          <ci> sp_Grb2_SH2 </ci>
        </apply>
        <apply>
          <times />
          <ci> km4 </ci>
          <ci> sp_EGFR_Grb2_P </ci>
        </apply>
      </apply>
    </math>
  </kineticLaw>
</reaction>

<!-- # Grb2 binding to Sos1 -->
<!-- 6 Grb2(SH3) + Sos1(PxxP) <-> Grb2(SH3!1).Sos1(PxxP!1) kp5,km5 -->
<reaction id="rc_Grb2_binding_to_Sos1" reversible="true" fast="false">
  <listOfReactants>
    <speciesReference species="sp_Grb2_SH3" constant="false" />
    <speciesReference species="sp_Sos1_free" constant="false" />
  </listOfReactants>
  <listOfProducts>
    <speciesReference species="sp_Grb2_Sos1" constant="false" />
  </listOfProducts>
  <kineticLaw>
    <math xmlns="http://www.w3.org/1998/Math/MathML">
      <apply>
        <minus />
        <apply>
          <times />
          <ci> kp5 </ci>
          <ci> sp_Grb2_SH3 </ci>
          <ci> sp_Sos1_free </ci>
        </apply>
        <apply>
          <times />
          <ci> km5 </ci>
          <ci> sp_Grb2_Sos1 </ci>
        </apply>
      </apply>
    </math>
  </kineticLaw>
</reaction>

<!-- # Receptor dimer internalization/degradation -->
<!-- 7 EGF(R!1).EGF(R!2).EGFR(L!1,CR1!3).EGFR(L!2,CR1!3) -> Trash() -->
<reaction id="rc_EGFR_EGF_dimer_degration" reversible="false" fast="false">
  <listOfReactants>
    <speciesReference species="sp_EGFR_EGF_dimer" constant="false" />
  </listOfReactants>
  <listOfProducts>
    <speciesReference species="sp_Trash" constant="false" />
  </listOfProducts>
  <kineticLaw>
    <math xmlns="http://www.w3.org/1998/Math/MathML">
      <apply>
        <times />
        <ci>deg</ci>

```

8
9
10
11
12
13
14
15
16
17
18
19
20
21
22
23
24
25
26
27
28
29
30
31
32
33
34
35
36
37
38
39
40
41
42
43
44
45
46
47
48
49
50
51
52
53
54
55
56
57
58
59
60
61
62
63
64
65
66
1
2
3
4
5
6
7

```

      <ci>sp_EGFR_EGF_dimer</ci>
    </apply>
  </math>
</kineticLaw>
</reaction>
</listOfReactions>
</model>
</sbml>

```

4.5 Mappings between reactants and products in a published model

This example coding the mappings between reactants and products is taken from a published model (Mu et al. (2007)).

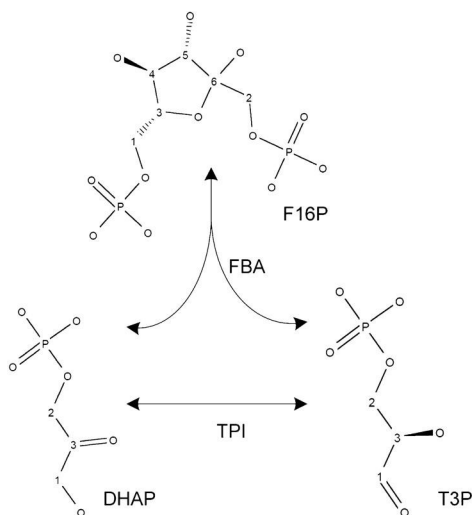

Figure 20: The reactions of F16P, DHAP and T3P described in the paper by Mu et al. (2007)

Figure 20 is cited from the original paper and has the mappings between “F16P” and “DHAP + T3P” as follows:

1. Carbon atom 1 in F16P corresponds to Carbon atom 2 in T3P
2. Carbon atom 2 in F16P corresponds to Carbon atom 2 in DHAP
3. Carbon atom 3 in F16P corresponds to Carbon atom 3 in T3P
4. Carbon atom 4 in F16P corresponds to Carbon atom 1 in T3P
5. Carbon atom 5 in F16P corresponds to Carbon atom 1 in DHAP
6. Carbon atom 6 in F16P corresponds to Carbon atom 3 in DHAP

The SBML code in the format of the Multi package can be as follows.

Note:

In the biochemical structure diagram in Figure 20, all “binding sites” of oxygen and carbon atoms without explicit binding partners are understood to be bound to hydrogens. But those bonds are not important here for the purpose illustrating the mappings of carbon atoms and therefore the “binding sites” are simply assigned a “bound” state in the SBML code.

```
<?xml version="1.0" encoding="UTF-8"?>
```

```

8 <sbml xmlns="http://www.sbml.org/sbml/level3/version1/core" level="3" version="1"
9   xmlns:multi="http://www.sbml.org/sbml/level3/version1/multi/version1" multi:required="true">
10   <model name="Carbon-fate">
11     <multi:listOfSpeciesTypes>
12       <multi:bindingSiteSpeciesType multi:id="stCbindingSite" />
13       <multi:speciesType multi:id="stC">
14         <multi:listOfSpeciesTypeInstances>
15           <multi:speciesTypeInstance multi:id="cbs" multi:speciesType="stCbindingSite"
16             multi:occur="4" />
17         </multi:listOfSpeciesTypeInstances>
18       </multi:speciesType>
19
20       <multi:bindingSiteSpeciesType multi:id="stObindingSite" />
21       <multi:speciesType multi:id="stO">
22         <multi:listOfSpeciesTypeInstances>
23           <multi:speciesTypeInstance multi:id="obs" multi:speciesType="stObindingSite"
24             multi:occur="2" />
25         </multi:listOfSpeciesTypeInstances>
26       </multi:speciesType>
27
28       <multi:bindingSiteSpeciesType multi:id="stPbindingSite" />
29       <multi:speciesType multi:id="stP">
30         <multi:listOfSpeciesTypeInstances>
31           <multi:speciesTypeInstance multi:id="pbs" multi:speciesType="stPbindingSite"
32             multi:occur="5" />
33         </multi:listOfSpeciesTypeInstances>
34       </multi:speciesType>
35
36       <multi:speciesType multi:id="stPhosphate">
37         <multi:listOfSpeciesTypeInstances>
38           <multi:speciesTypeInstance multi:id="P" multi:speciesType="stP" multi:occur="1" />
39           <multi:speciesTypeInstance multi:id="O" multi:speciesType="stO" multi:occur="4" />
40         </multi:listOfSpeciesTypeInstances>
41         <multi:listOfSpeciesTypeComponentIndexes>
42
43           <!-- oxygens -->
44           <multi:speciesTypeComponentIndex multi:id="O1" multi:component="O" multi:occur="1" />
45           <multi:speciesTypeComponentIndex multi:id="O2" multi:component="O" multi:occur="1" />
46           <multi:speciesTypeComponentIndex multi:id="O3" multi:component="O" multi:occur="1" />
47           <multi:speciesTypeComponentIndex multi:id="O4" multi:component="O" multi:occur="1" />
48
49           <!-- binding sites of oxygens -->
50           <multi:speciesTypeComponentIndex multi:id="P01b1"
51             multi:component="obs" multi:identifyingParent="O1" multi:occur="1" />
52           <multi:speciesTypeComponentIndex multi:id="P01b2"
53             multi:component="obs" multi:identifyingParent="O1" multi:occur="1" />
54           <multi:speciesTypeComponentIndex multi:id="P02b1"
55             multi:component="obs" multi:identifyingParent="O2" multi:occur="1" />
56           <multi:speciesTypeComponentIndex multi:id="P02b2"
57             multi:component="obs" multi:identifyingParent="O2" multi:occur="1" />
58           <multi:speciesTypeComponentIndex multi:id="P03b1"
59             multi:component="obs" multi:identifyingParent="O3" multi:occur="1" />
60           <multi:speciesTypeComponentIndex multi:id="P03b2"
61             multi:component="ob2" multi:identifyingParent="O3" multi:occur="1" />
62           <multi:speciesTypeComponentIndex multi:id="P04bb"
63             multi:component="obs" multi:identifyingParent="O4" multi:occur="2" />
64
65           <!-- binding sites of phosphorus -->
66           <multi:speciesTypeComponentIndex multi:id="pb1"
67             multi:component="pbs" multi:identifyingParent="P" multi:occur="1" />
68           <multi:speciesTypeComponentIndex multi:id="pb2"
69             multi:component="pbs" multi:identifyingParent="P" multi:occur="1" />
70           <multi:speciesTypeComponentIndex multi:id="pb3"
71             multi:component="pbs" multi:identifyingParent="P" multi:occur="1" />
72           <multi:speciesTypeComponentIndex multi:id="pbb"
73             multi:component="pbs" multi:identifyingParent="P" multi:occur="2" />

```

```

</multi:listOfSpeciesTypeComponentIndexes>

<multi:listOfInSpeciesTypeBonds>
  <multi:inSpeciesTypeBond multi:bindingSite1="P01b1" multi:bindingSite2="pb1" />
  <multi:inSpeciesTypeBond multi:bindingSite1="P02b1" multi:bindingSite2="pb2" />
  <multi:inSpeciesTypeBond multi:bindingSite1="P03b1" multi:bindingSite2="pb3" />
  <multi:inSpeciesTypeBond multi:bindingSite1="P04bb" multi:bindingSite2="pbb" />
</multi:listOfInSpeciesTypeBonds>
</multi:speciesType>

<multi:speciesType multi:id="stDHAP">
  <multi:listOfSpeciesTypeInstances>
    <multi:speciesTypeInstance multi:id="phosphate"
      multi:speciesType="stPhosphate" multi:occur="1" />
    <multi:speciesTypeInstance multi:id="C2" multi:speciesType="stC" multi:occur="1" />
    <multi:speciesTypeInstance multi:id="C3" multi:speciesType="stC" multi:occur="1" />
    <multi:speciesTypeInstance multi:id="Oc3" multi:speciesType="stO" multi:occur="1" />
    <multi:speciesTypeInstance multi:id="C1" multi:speciesType="stC" multi:occur="1" />
    <multi:speciesTypeInstance multi:id="Oc1" multi:speciesType="stO" multi:occur="1" />
  </multi:listOfSpeciesTypeInstances>
  <multi:listOfSpeciesTypeComponentIndexes>

    <!-- binding sites of C2 -->
    <multi:speciesTypeComponentIndex multi:id="C2b1"
      multi:component="cbs" multi:identifyingParent="C2" multi:occur="1" />
    <multi:speciesTypeComponentIndex multi:id="C2b23"
      multi:component="cbs" multi:identifyingParent="C2" multi:occur="2" />
    <multi:speciesTypeComponentIndex multi:id="C2b4"
      multi:component="cbs" multi:identifyingParent="C2" multi:occur="1" />

    <!-- binding sites of C3 -->
    <multi:speciesTypeComponentIndex multi:id="C3b1"
      multi:component="cbs" multi:identifyingParent="C3" multi:occur="1" />
    <multi:speciesTypeComponentIndex multi:id="C3b23"
      multi:component="cbs" multi:identifyingParent="C3" multi:occur="2" />
    <multi:speciesTypeComponentIndex multi:id="C3b4"
      multi:component="cbs" multi:identifyingParent="C3" multi:occur="1" />

    <!-- binding sites of C1 -->
    <multi:speciesTypeComponentIndex multi:id="C1b1"
      multi:component="cbs" multi:identifyingParent="C1" multi:occur="1" />
    <multi:speciesTypeComponentIndex multi:id="C1b23"
      multi:component="cbs" multi:identifyingParent="C1" multi:occur="2" />
    <multi:speciesTypeComponentIndex multi:id="C1b4"
      multi:component="cbs" multi:identifyingParent="C1" multi:occur="1" />

    <!-- binding sites of Oc3 -->
    <multi:speciesTypeComponentIndex multi:id="Oc3bb"
      multi:component="obs" multi:identifyingParent="Oc3" multi:occur="2" />

    <!-- binding sites of Oc1 -->
    <multi:speciesTypeComponentIndex multi:id="Oc1b1"
      multi:component="obs" multi:identifyingParent="Oc1" multi:occur="1" />
    <multi:speciesTypeComponentIndex multi:id="Oc1b2"
      multi:component="obs" multi:identifyingParent="Oc1" multi:occur="1" />

  </multi:listOfSpeciesTypeComponentIndexes>

  <multi:listOfInSpeciesTypeBonds>
    <multi:inSpeciesTypeBond multi:bindingSite1="P01b2"
      multi:bindingSite2="C2b1" />
    <multi:inSpeciesTypeBond multi:bindingSite1="C2b2"
      multi:bindingSite2="C3b1" />
    <multi:inSpeciesTypeBond multi:bindingSite1="C3b23"
      multi:bindingSite2="Oc3bb" />
  </multi:listOfInSpeciesTypeBonds>

```

```

<multi:inSpeciesTypeBond multi:bindingSite1="C3b4"
  multi:bindingSite2="C1b1" />
<multi:inSpeciesTypeBond multi:bindingSite1="C1b2"
  multi:bindingSite2="Oc1b1" />
</multi:listOfInSpeciesTypeBonds>
</multi:speciesType>

<multi:speciesType multi:id="stT3P">
  <multi:listOfSpeciesTypeInstances>
    <multi:speciesTypeInstance multi:id="phosphate"
      multi:speciesType="stPhosphate" multi:occur="1" />
    <multi:speciesTypeInstance multi:id="C2" multi:speciesType="stC"
      multi:occur="1" />
    <multi:speciesTypeInstance multi:id="C3" multi:speciesType="stC"
      multi:occur="1" />
    <multi:speciesTypeInstance multi:id="Oc3" multi:speciesType="stO"
      multi:occur="1" />
    <multi:speciesTypeInstance multi:id="C1" multi:speciesType="stC"
      multi:occur="1" />
    <multi:speciesTypeInstance multi:id="Oc1" multi:speciesType="stO"
      multi:occur="1" />
  </multi:listOfSpeciesTypeInstances>
  <multi:listOfSpeciesTypeComponentIndexes>

    <!-- binding sites of C2 -->
    <multi:speciesTypeComponentIndex multi:id="C2b1"
      multi:component="cbs" multi:identifyingParent="C2" multi:occur="1" />
    <multi:speciesTypeComponentIndex multi:id="C2b23"
      multi:component="cbs" multi:identifyingParent="C2" multi:occur="2" />
    <multi:speciesTypeComponentIndex multi:id="C2b4"
      multi:component="cbs" multi:identifyingParent="C2" multi:occur="1" />

    <!-- binding sites of C3 -->
    <multi:speciesTypeComponentIndex multi:id="C3b1"
      multi:component="cbs" multi:identifyingParent="C3" multi:occur="1" />
    <multi:speciesTypeComponentIndex multi:id="C3b2"
      multi:component="cbs" multi:identifyingParent="C3" multi:occur="1" />
    <multi:speciesTypeComponentIndex multi:id="C3b3"
      multi:component="cbs" multi:identifyingParent="C3" multi:occur="1" />
    <multi:speciesTypeComponentIndex multi:id="C3b4"
      multi:component="cbs" multi:identifyingParent="C3" multi:occur="1" />

    <!-- binding sites of C1 -->
    <multi:speciesTypeComponentIndex multi:id="C1b1"
      multi:component="cbs" multi:identifyingParent="C1" multi:occur="1" />
    <multi:speciesTypeComponentIndex multi:id="C1b23"
      multi:component="cbs" multi:identifyingParent="C1" multi:occur="2" />
    <multi:speciesTypeComponentIndex multi:id="C1b4"
      multi:component="cbs" multi:identifyingParent="C1" multi:occur="1" />

    <!-- binding sites of Oc3 -->
    <multi:speciesTypeComponentIndex multi:id="Oc3b1"
      multi:component="obs" multi:identifyingParent="Oc3" multi:occur="1" />
    <multi:speciesTypeComponentIndex multi:id="Oc3b2"
      multi:component="obs" multi:identifyingParent="Oc3" multi:occur="1" />

    <!-- binding sites of Oc1 -->
    <multi:speciesTypeComponentIndex multi:id="Oc1bb"
      multi:component="obs" multi:identifyingParent="Oc1" multi:occur="2" />

  </multi:listOfSpeciesTypeComponentIndexes>

  <multi:listOfInSpeciesTypeBonds>
    <multi:inSpeciesTypeBond multi:bindingSite1="P01b2"
      multi:bindingSite2="C2b1" />
    <multi:inSpeciesTypeBond multi:bindingSite1="C2b2"

```

```

    multi:bindingSite2="C3b1" />
<multi:inSpeciesTypeBond multi:bindingSite1="C3b2"
  multi:bindingSite2="Oc3b1" />
<multi:inSpeciesTypeBond multi:bindingSite1="C3b4"
  multi:bindingSite2="C1b1" />
<multi:inSpeciesTypeBond multi:bindingSite1="C1b23"
  multi:bindingSite2="Oc1bb" />
</multi:listOfInSpeciesTypeBonds>
</multi:speciesType>

<multi:speciesType multi:id="stF16P">
  <multi:listOfSpeciesTypeInstances>
    <multi:speciesTypeInstance multi:id="phosphate1" multi:speciesType="stPhosphate"
      multi:occur="1" /> <!-- T3P phosphate -->
    <multi:speciesTypeInstance multi:id="C1" multi:speciesType="stC"
      multi:occur="1" /> <!-- T3P C2 -->
    <multi:speciesTypeInstance multi:id="C3" multi:speciesType="stC"
      multi:occur="1" /> <!-- T3P C3 -->
    <multi:speciesTypeInstance multi:id="Oc3" multi:speciesType="stO"
      multi:occur="1" /> <!-- T3P Oc3 -->
    <multi:speciesTypeInstance multi:id="C4" multi:speciesType="stC"
      multi:occur="1" /> <!-- T3P C1 -->
    <multi:speciesTypeInstance multi:id="Oc4" multi:speciesType="stO"
      multi:occur="1" /> <!-- T3P Oc1 -->
    <multi:speciesTypeInstance multi:id="phosphate2" multi:speciesType="stPhosphate"
      multi:occur="1" /> <!-- DHAP phosphate -->
    <multi:speciesTypeInstance multi:id="C2" multi:speciesType="stC"
      multi:occur="1" /> <!-- DHAP C2 -->
    <multi:speciesTypeInstance multi:id="C6" multi:speciesType="stC"
      multi:occur="1" /> <!-- DHAP C3 -->
    <multi:speciesTypeInstance multi:id="Oc6" multi:speciesType="stO"
      multi:occur="1" /> <!-- DHAP Oc3 -->
    <multi:speciesTypeInstance multi:id="C5" multi:speciesType="stC"
      multi:occur="1" /> <!-- DHAP C1 -->
    <multi:speciesTypeInstance multi:id="Oc5" multi:speciesType="stO"
      multi:occur="1" /> <!-- DHAP Oc1 -->
  </multi:listOfSpeciesTypeInstances>

  <multi:listOfSpeciesTypeComponentIndexes>
    <!-- Oxygen binding sites in phosphate1 -->
    <multi:speciesTypeComponentIndex multi:id="P101b2"
      multi:component="P01b2" multi:identifyingParent="phosphate1" />
    <multi:speciesTypeComponentIndex multi:id="P102b2"
      multi:component="P02b2" multi:identifyingParent="phosphate1" />
    <multi:speciesTypeComponentIndex multi:id="P103b2"
      multi:component="P03b2" multi:identifyingParent="phosphate1" />

    <!-- Oxygen binding sites in phosphate1 -->
    <multi:speciesTypeComponentIndex multi:id="P201b2"
      multi:component="P01b2" multi:identifyingParent="phosphate2" />
    <multi:speciesTypeComponentIndex multi:id="P202b2"
      multi:component="P02b2" multi:identifyingParent="phosphate2" />
    <multi:speciesTypeComponentIndex multi:id="P203b2"
      multi:component="P03b2" multi:identifyingParent="phosphate2" />

    <!-- binding sites of C1 -->
    <multi:speciesTypeComponentIndex multi:id="C1b1"
      multi:component="cbs" multi:identifyingParent="C1" multi:occur="1" />
    <multi:speciesTypeComponentIndex multi:id="C1b23"
      multi:component="cbs" multi:identifyingParent="C1" multi:occur="2" />
    <multi:speciesTypeComponentIndex multi:id="C1b4"
      multi:component="cbs" multi:identifyingParent="C1" multi:occur="1" />

    <!-- binding sites of C3 -->
    <multi:speciesTypeComponentIndex multi:id="C3b1"
      multi:component="cbs" multi:identifyingParent="C3" multi:occur="1" />

```

```

<multi:speciesTypeComponentIndex multi:id="C3b2"
  multi:component="cbs" multi:identifyingParent="C3" multi:occur="1" />
<multi:speciesTypeComponentIndex multi:id="C3b3"
  multi:component="cbs" multi:identifyingParent="C3" multi:occur="1" />
<multi:speciesTypeComponentIndex multi:id="C3b4"
  multi:component="cbs" multi:identifyingParent="C3" multi:occur="1" />

<!-- binding sites of Oc3 -->
<multi:speciesTypeComponentIndex multi:id="Oc3b1"
  multi:component="obs" multi:identifyingParent="Oc3" multi:occur="1" />
<multi:speciesTypeComponentIndex multi:id="Oc3b2"
  multi:component="obs" multi:identifyingParent="Oc3" multi:occur="1" />

<!-- binding sites of C4 -->
<multi:speciesTypeComponentIndex multi:id="C4b1"
  multi:component="cbs" multi:identifyingParent="C4" multi:occur="1" />
<multi:speciesTypeComponentIndex multi:id="C4b2"
  multi:component="cbs" multi:identifyingParent="C4" multi:occur="1" />
<multi:speciesTypeComponentIndex multi:id="C4b3"
  multi:component="cbs" multi:identifyingParent="C4" multi:occur="1" />
<multi:speciesTypeComponentIndex multi:id="C4b4"
  multi:component="cbs" multi:identifyingParent="C4" multi:occur="1" />

<!-- binding sites of Oc4 -->
<multi:speciesTypeComponentIndex multi:id="Oc4b1"
  multi:component="ob1" multi:identifyingParent="Oc4" multi:occur="1" />
<multi:speciesTypeComponentIndex multi:id="Oc4b2"
  multi:component="ob2" multi:identifyingParent="Oc4" multi:occur="1" />

<!-- binding sites of C5 -->
<multi:speciesTypeComponentIndex multi:id="C5b1"
  multi:component="cbs" multi:identifyingParent="C5" multi:occur="1" />
<multi:speciesTypeComponentIndex multi:id="C5b2"
  multi:component="cbs" multi:identifyingParent="C5" multi:occur="1" />
<multi:speciesTypeComponentIndex multi:id="C5b3"
  multi:component="cbs" multi:identifyingParent="C5" multi:occur="1" />
<multi:speciesTypeComponentIndex multi:id="C5b4"
  multi:component="cbs" multi:identifyingParent="C5" multi:occur="1" />

<!-- binding sites of Oc5 -->
<multi:speciesTypeComponentIndex multi:id="Oc5b1"
  multi:component="obs" multi:identifyingParent="Oc5" multi:occur="1" />
<multi:speciesTypeComponentIndex multi:id="Oc5b2"
  multi:component="obs" multi:identifyingParent="Oc5" multi:occur="1" />

<!-- binding sites of C6 -->
<multi:speciesTypeComponentIndex multi:id="C6b1"
  multi:component="cbs" multi:identifyingParent="C6" multi:occur="1" />
<multi:speciesTypeComponentIndex multi:id="C6b2"
  multi:component="cbs" multi:identifyingParent="C6" multi:occur="1" />
<multi:speciesTypeComponentIndex multi:id="C6b3"
  multi:component="cbs" multi:identifyingParent="C6" multi:occur="1" />
<multi:speciesTypeComponentIndex multi:id="C6b4"
  multi:component="cbs" multi:identifyingParent="C6" multi:occur="1" />

<!-- binding sites of Oc6 -->
<multi:speciesTypeComponentIndex multi:id="Oc6b1"
  multi:component="ob1" multi:identifyingParent="Oc6" multi:occur="1" />
<multi:speciesTypeComponentIndex multi:id="Oc6b2"
  multi:component="ob2" multi:identifyingParent="Oc6" multi:occur="1" />

<!-- binding sites of C2 -->
<multi:speciesTypeComponentIndex multi:id="C2b1"
  multi:component="cbs" multi:identifyingParent="C2" multi:occur="1" />
<multi:speciesTypeComponentIndex multi:id="C2b2"
  multi:component="cbs" multi:identifyingParent="C2" multi:occur="1" />

```

```

</multi:listOfSpeciesTypeComponentIndexes>
<multi:listOfInSpeciesTypeBonds>
  <multi:inSpeciesTypeBond multi:bindingSite1="P101b2"
    multi:bindingSite2="C1b1" />
  <multi:inSpeciesTypeBond multi:bindingSite1="C1b4"
    multi:bindingSite2="C3b1" />
  <multi:inSpeciesTypeBond multi:bindingSite1="C3b2"
    multi:bindingSite2="Oc3b1" />
  <multi:inSpeciesTypeBond multi:bindingSite1="C3b4"
    multi:bindingSite2="C4b1" />
  <multi:inSpeciesTypeBond multi:bindingSite1="C4b2"
    multi:bindingSite2="Oc4b1" />
  <multi:inSpeciesTypeBond multi:bindingSite1="C4b4"
    multi:bindingSite2="C5b1" />
  <multi:inSpeciesTypeBond multi:bindingSite1="C5b2"
    multi:bindingSite2="Oc5b1" />
  <multi:inSpeciesTypeBond multi:bindingSite1="C5b4"
    multi:bindingSite2="C6b1" />
  <multi:inSpeciesTypeBond multi:bindingSite1="C6b2"
    multi:bindingSite2="Oc3b2" />
  <multi:inSpeciesTypeBond multi:bindingSite1="C6b3"
    multi:bindingSite2="Oc6b1" />
  <multi:inSpeciesTypeBond multi:bindingSite1="C6b4"
    multi:bindingSite2="C2b1" />
  <multi:inSpeciesTypeBond multi:bindingSite1="C2b2"
    multi:bindingSite2="P201b2" />
</multi:listOfInSpeciesTypeBonds>
</multi:speciesType>
</multi:listOfSpeciesTypes>
<listOfSpecies>
  <species id="F16P" multi:speciesType="stF16P" hasOnlySubstanceUnits="false"
    boundaryCondition="false" constant="false">
    <multi:listOfOutwardBindingSites>
      <multi:outwardBindingSite component="C1b23" multi:bindingStatus="bound" />
      <multi:outwardBindingSite component="C3b3" multi:bindingStatus="bound" />
      <multi:outwardBindingSite component="Oc4b2" multi:bindingStatus="bound" />
      <multi:outwardBindingSite component="C5b3" multi:bindingStatus="bound" />
      <multi:outwardBindingSite component="Oc6b2" multi:bindingStatus="bound" />
      <multi:outwardBindingSite component="C2b23" multi:bindingStatus="bound" />
      <multi:outwardBindingSite component="P102b2" multi:bindingStatus="bound" />
      <multi:outwardBindingSite component="P103b2" multi:bindingStatus="bound" />
      <multi:outwardBindingSite component="P202b2" multi:bindingStatus="bound" />
      <multi:outwardBindingSite component="P203b2" multi:bindingStatus="bound" />
    </multi:listOfOutwardBindingSites>
  </species>
  <species id="DHAP" multi:speciesType="stDHAP" hasOnlySubstanceUnits="false"
    boundaryCondition="false" constant="false">
    <multi:outwardBindingSite component="P02b2" multi:bindingStatus="bound" />
    <multi:outwardBindingSite component="P03b2" multi:bindingStatus="bound" />
    <multi:outwardBindingSite component="C2b23" multi:bindingStatus="bound" />
    <multi:outwardBindingSite component="C1b23" multi:bindingStatus="bound" />
  </species>
  <species id="T3P" multi:speciesType="stT3P" hasOnlySubstanceUnits="false"
    boundaryCondition="false" constant="false">
    <multi:outwardBindingSite component="P02b2" multi:bindingStatus="bound" />
    <multi:outwardBindingSite component="P03b2" multi:bindingStatus="bound" />
    <multi:outwardBindingSite component="C2b23" multi:bindingStatus="bound" />
    <multi:outwardBindingSite component="C3b3" multi:bindingStatus="bound" />
    <multi:outwardBindingSite component="C1b4" multi:bindingStatus="bound" />
  </species>
  <species id="FBA" ... />
  <species id="TPI" ... />
</listOfSpecies>
</listOfReactions>

```



```

8 <reaction id="rc" reversible="true" fast="false">
9   <listOfReactants>
10     <speciesReference species="F16P" constant="false" />
11   </listOfReactants>
12   <listOfProducts>
13     <speciesReference species="DHAP" constant="false">
14       <multi:listOfSpeciesTypeComponentMapsInProduct>
15         <multi:speciesTypeComponentMapInProduct
16           multi:reactantComponent="C5" multi:reactant="F16P"
17           multi:productComponent="C1" />
18         <multi:speciesTypeComponentMapInProduct
19           multi:reactantComponent="C2" multi:reactant="F16P"
20           multi:productComponent="C2" />
21         <multi:speciesTypeComponentMapInProduct
22           multi:reactantComponent="C6" multi:reactant="F16P"
23           multi:productComponent="C3" />
24       </multi:listOfSpeciesTypeComponentMapsInProduct>
25     </speciesReference>
26     <speciesReference species="T3P" constant="false">
27       <multi:listOfSpeciesTypeComponentMapsInProduct>
28         <multi:speciesTypeComponentMapInProduct
29           multi:reactantComponent="C4" multi:reactant="F16P"
30           multi:productComponent="C1" />
31         <multi:speciesTypeComponentMapInProduct
32           multi:reactantComponent="C1" multi:reactant="F16P"
33           multi:productComponent="C2" />
34         <multi:speciesTypeComponentMapInProduct
35           multi:reactantComponent="C3" multi:reactant="F16P"
36           multi:productComponent="C3" />
37       </multi:listOfSpeciesTypeComponentMapsInProduct>
38     </speciesReference>
39   </listOfProducts>
40   <listOfModifierSpeciesReferences>
41     <ModifierSpeciesReference species="FBA" />
42   </listOfModifierSpeciesReferences>
43   ...
44 </reaction>
45 <reaction reversible="true" fast="false">
46   <listOfReactants>
47     <speciesReference species="DHAP" />
48   </listOfReactants>
49   <listOfProducts>
50     <speciesReference species="T3P">
51       <multi:listOfSpeciesTypeComponentMapsInProduct>
52         <multi:speciesTypeComponentMapInProduct multi:reactantComponent="C1"
53           multi:reactant="DHAP" multi:productComponent="C1" />
54         <multi:speciesTypeComponentMapInProduct multi:reactantComponent="C2"
55           multi:reactant="DHAP" multi:productComponent="C2" />
56         <multi:speciesTypeComponentMapInProduct multi:reactantComponent="C3"
57           multi:reactant="DHAP" multi:productComponent="C3" />
58       </multi:listOfSpeciesTypeComponentMapsInProduct>
59     </speciesReference>
60   </listOfProducts>
61   <listOfModifierSpeciesReferences>
62     <ModifierSpeciesReference species="TPI" />
63   </listOfModifierSpeciesReferences>
64   ...
65 </reaction>
66 </listOfReactions>
67 </model>
68 </sbml>

```

4.6 Example from *Kappa*'s documentation

Here is the example “An Introduction to Kappa Syntax” at *Kappa* website (<http://www.kappalanguage.org/syntax.html>).

Rule in English: “Unphosphorylated Site1 of A binds to Site1 of B”

Kappa Rule: A(Site1 u),B(Site1) -> A(Site1 u!1),B(Site1!1)

```

<?xml version="1.0" encoding="UTF-8"?>
<sbml xmlns="http://www.sbml.org/sbml/level3/version1/core" level="3" version="1"
  xmlns:multi="http://www.sbml.org/sbml/level3/version1/multi/version1" multi:required="true">

  <model name="An_Introduction_to_Kappa_Syntax">
    ...
    <!-- speciesType -->
    <multi:listOfSpeciesTypes>

      <!-- A:Site1 -->
      <multi:bindingSiteSpeciesType multi:id="st_A_Site1">
        <multi:listOfSpeciesFeatureTypes>
          <multi:speciesFeatureType multi:id="phosphorylation">
            <multi:listOfPossibleSpeciesFeatureValues>
              <multi:possibleSpeciesFeatureValue multi:id="U" />
              <multi:possibleSpeciesFeatureValue multi:id="P" />
            </multi:listOfPossibleSpeciesFeatureValues>
          </multi:speciesFeatureType>
        </multi:listOfSpeciesFeatureTypes>
      </multi:bindingSiteSpeciesType>

      <!-- A -->
      <multi:speciesType multi:id="st_A">
        <multi:listOfSpeciesTypeInstances>
          <multi:speciesTypeInstance multi:id="Asite1" multi:speciesType="st_A_Site1"
            multi:occur="1" />
        </multi:listOfSpeciesTypeInstances>
      </multi:speciesType>

      <!-- B:Site1 -->
      <multi:bindingSiteSpeciesType multi:id="st_B_Site1" />

      <!-- B -->
      <multi:speciesType multi:id="st_B">
        <multi:listOfSpeciesTypeInstances>
          <multi:speciesTypeInstance multi:id="Bsite1" multi:speciesType="st_B_Site1"
            multi:occur="1" />
        </multi:listOfSpeciesTypeInstances>
      </multi:speciesType>

      <!-- A.B -->
      <multi:speciesType multi:id="st_AB">
        <multi:listOfSpeciesTypeInstances>
          <multi:speciesTypeInstance multi:id="A" multi:speciesType="st_A" multi:occur="1" />
          <multi:speciesTypeInstance multi:id="B" multi:speciesType="st_B" multi:occur="1" />
        </multi:listOfSpeciesTypeInstances>
        <multi:listOfInSpeciesTypeBonds>
          <multi:inSpeciesTypeBond multi:bindingSite1="Asite1"
            multi:bindingSite2="Bsite1" />
        </multi:listOfInSpeciesTypeBonds>
      </multi:speciesType>
      ...
    </multi:listOfSpeciesTypes>

    <!-- species -->
    <listOfSpecies>
      <!-- species A with free unphosphorylated Site1 -->

```

```

<species id="sp_A" name="A_with_Unphosphorylated_Site_1" multi:speciesType="st_A"
  hasOnlySubstanceUnits="false" boundaryCondition="false" constant="false">
  <multi:listOfOutwardBindingSites>
    <multi:outwardBindingSite multi:component="Asite1"
      multi:bindingStatus="unbound" />
  </multi:listOfOutwardBindingSites>
  <multi:listOfSpeciesFeatures>
    <multi:speciesFeature multi:speciesFeatureType="phosphorylation">
      <multi:listOfSpeciesFeatureValues>
        <multi:speciesFeatureValue multi:value="U" />
      </multi:listOfSpeciesFeatureValues>
    </multi:speciesFeature>
  </multi:listOfSpeciesFeatures>
</species>

<!-- species B with free Site 1 -->
<species id="sp_B" name="B" multi:speciesType="st_B" hasOnlySubstanceUnits="false"
  boundaryCondition="false" constant="false">
  <multi:listOfOutwardBindingSites>
    <multi:outwardBindingSite multi:component="sti_B_Site1"
      multi:bindingStatus="unbound" />
  </multi:listOfOutwardBindingSites>
</species>

<!-- species AB: unphosphorylated -->
<species id="sp_AB" name="AB" multi:speciesType="st_AB" hasOnlySubstanceUnits="false"
  boundaryCondition="false" constant="false">
  <multi:listOfSpeciesFeatures>
    <multi:speciesFeature multi:speciesFeatureType="phosphorylation">
      <multi:listOfSpeciesFeatureValues>
        <multi:speciesFeatureValue multi:value="U" />
      </multi:listOfSpeciesFeatureValues>
    </multi:speciesFeature>
  </multi:listOfSpeciesFeatures>
</species>
...
</listOfSpecies>

<!-- reactions -->
<listOfReactions>

  <!-- Unphosphorylated Site1 of A binds to Site1 of B -->
  <!-- Kappa Rule: A(Site1~u),B(Site1) -> A(Site1~u!1),B(Site1!1) -->
  <reaction id="rc_AB" reversible="false" fast="false">
    <listOfReactants>
      <speciesReference species="sp_A" constant="false" />
      <speciesReference species="sp_B" constant="false" />
    </listOfReactants>
    <listOfProducts>
      <speciesReference species="sp_AB" constant="false" />
    </listOfProducts>
    <kineticLaw>
      ...
    </kineticLaw>
  </reaction>
  ...
</listOfReactions>
</model>
</sbml>

```

9
10
11
12
13
14
15
16
17
18
19
20
21
22
23
24
25
26
27
28
29
30
31
32
33
34
35
36
37
38
39
40
41
42
43
44
45
46
47
48
49
50
51
52
53
54
55
56
57
58
59
60
1
2
3
4
5
6
7
8

A Validation of SBML documents using Multi constructs

Note:

The whole validation section is new in this version of the specification of the Multi package.

This section summarizes all the conditions that should be true of an SBML Level 3 Version 1 model that uses the Multi package. We use the same conventions that are used in the SBML Level 3 Version 1 Core specification document. In particular, there are different degrees of rule strictness. Formally, the differences are expressed in the statement of a rule: either a rule states that a condition *must* be true, or a rule states that it *should* be true. Rules of the former kind are strict SBML validation rules—a model encoded in SBML must conform to all of them in order to be considered valid. Rules of the latter kind are consistency rules. To help highlight these differences, we use the three symbols (✓ - **requirement**, ▲ - **recommendation**, and ★ - **strong recommendation**) next to the rule numbers as described in section A of the SBML Level 3 Version 1 Core specification document.

The validation rules listed in the following subsections are all stated or implied in the rest of this specification document. They are enumerated here for convenience. Unless explicitly stated, all validation rules concern objects and attributes specifically defined in the Multi package.

For convenience and brevity, we use the shorthand “**multi:x**” to stand for an attribute or element name **x** in the namespace for the Multi package, using the namespace prefix **multi**. We use “**multi:x**” because it is shorter than to write a full explanation everywhere we refer to an attribute or element in the Multi package namespace.

General rules about the Multi package

- multi-10101** ✓ To conform to Version 1 of the Multi package specification for SBML Level 3, an SBML document must declare the use of the following XML Namespace: “<http://www.sbml.org/sbml/level3/version1/multi/version1>”. (References: SBML Level 3 Package Specification for Multi Version 1, [Section 3.1 on page 7.](#))
- multi-10102** ✓ Wherever they appear in an SBML document, elements and attributes from the Multi package must be declared either implicitly or explicitly to be in the XML namespace “<http://www.sbml.org/sbml/level3/version1/multi/version1>”. (References: SBML Level 3 Package Specification for Multi Version 1, [Section 3.1 on page 7.](#))
- multi-10103** ✓ The **multi:required** attribute is required on the **<sbml>** element in the Multi package. (References: SBML Level 3 Package Specification for Multi Version 1, [Section 3.1 on page 7.](#))
- multi-10104** ✓ The **multi:required** attribute on the **<sbml>** element must be **Boolean**. (References: SBML Level 3 Package Specification for Multi Version 1, [Section 3.1 on page 7.](#))
- multi-10105** ✓ The value of the **multi:required** attribute on the **<sbml>** element must be “**true**”. (References: SBML Level 3 Package Specification for Multi Version 1, [Section 3.1 on page 7.](#))

General rules about identifiers

- multi-10301** ✓ (Extends validation rule #10301 in the SBML Level 3 Version 1 Core specification.) Within a **Model** object, the values of the attributes **id** and **multi:id** on every instance of the following classes of objects must be unique across the set of all **id** and **multi:id** attribute values of all such objects in a model: the **Model** itself, plus all contained **FunctionDefinition**, **Compartment**, **Species**, **Reaction**, **SpeciesReference**, **ModifierSpeciesReference**, **Event**, and **Parameter** objects, plus the **SpeciesType** objects defined by the Multi package, plus any objects defined by any other package with **package:id** attributes defined as falling in the ‘Sid’ namespace. (References: [Section 3.28 on page 48.](#))
- multi-10302** ✓ The value of a **multi:id** attribute must always conform to the syntax of the SBML data type

| | | |
|----------------------|--|----------------------|
| | SIId. (References: SBML Level 3 Version 1 Core, Section 3.1.7.) | 9 |
| multi-10303 ✓ | The value of a <code>multi:name</code> attribute must always conform to the syntax of type <code>string</code> . (References: SBML Level 3 Version 1 Core, Section 3.1.1.) | 10 11 |
| multi-10401 ✓ | The value of a <code>multi:id</code> attribute on <code>SpeciesTypeInstance</code> objects must be unique across the set of all <code>multi:id</code> attribute values of all objects in the <code>SpeciesType</code> object in which it is located. (References: Section 3.11.1 on page 16 and Section 3.28 on page 48 .) | 12 13 14 |
| multi-10402 ✓ | The value of a <code>multi:id</code> attribute on <code>SpeciesTypeComponentIndex</code> objects must be unique across the set of all <code>multi:id</code> attribute values of all objects in the <code>SpeciesType</code> object in which it is located. (References: Section 3.12.1 on page 18 and Section 3.28 on page 48 .) | 15 16 17 |
| multi-10403 ✓ | The value of a <code>multi:id</code> attribute on <code>InSpeciesTypeBond</code> objects must be unique across the set of all <code>multi:id</code> attribute values of all objects in the <code>SpeciesType</code> object in which it is located. (References: Section 3.14.1 on page 22 and Section 3.28 on page 48 .) | 18 19 20 |
| multi-10404 ✓ | The value of a <code>multi:id</code> attribute on <code>PossibleSpeciesFeatureValue</code> objects must be unique across the set of all <code>multi:id</code> attribute values of all objects in the <code>SpeciesType</code> object in which it is located. (References: Section 3.10.1 on page 15 and Section 3.28 on page 48 .) | 21 22 23 |
| multi-10405 ✓ | The value of a <code>multi:id</code> attribute on <code>SpeciesFeature</code> objects must be unique across the set of all <code>id</code> and <code>multi:id</code> attribute values of all objects in the <code>Species</code> object in which it is located. (References: Section 3.18.1 on page 29 and Section 3.28 on page 48 .) | 24 25 26 |
| multi-10406 ✓ | The value of a <code>multi:id</code> attribute on <code>SpeciesFeatureChange</code> objects must be unique across the set of all <code>multi:id</code> attribute values of all objects in the <code>SpeciesTypeComponentMapInProduct</code> object in which it is located. (References: Section 3.25.1 on page 42 and Section 3.28 on page 48 .) | 27 28 29 30 |
| multi-10407 ✓ | The value of a <code>multi:id</code> attribute on <code>CompartmentReference</code> objects must be unique across the set of all <code>id</code> and <code>multi:id</code> attribute values of all objects in the <code>Compartment</code> object in which it is located. (References: Section 3.6.1 on page 11 and Section 3.28 on page 48 .) | 31 32 33 |
| multi-10501 ✓ | The value of a <code>multi:compartment</code> attribute on <code>SpeciesType</code> objects must conform to the syntax of the SBML data type <code>SIIdRef</code> . (References: Section 3.8.2 on page 12 .) | 34 35 |
| multi-10502 ✓ | The value of a <code>multi:numericValue</code> attribute on <code>PossibleSpeciesFeatureValue</code> objects must conform to the syntax of the SBML data type <code>SIIdRef</code> . (References: Section 3.10.2 on page 15 .) | 36 37 |
| multi-10503 ✓ | The value of a <code>multi:speciesType</code> attribute on <code>SpeciesTypeInstance</code> objects must conform to the syntax of the SBML data type <code>SIIdRef</code> . (References: Section 3.11.2 on page 16 .) | 38 39 |
| multi-10504 ✓ | The value of a <code>multi:compartmentReference</code> attribute on <code>SpeciesTypeInstance</code> objects must conform to the syntax of the SBML data type <code>SIIdRef</code> . (References: Section 3.11.3 on page 16 .) | 40 41 |
| multi-10505 ✓ | The value of a <code>multi:component</code> attribute on <code>SpeciesTypeComponentIndex</code> objects must conform to the syntax of the SBML data type <code>SIIdRef</code> . (References: Section 3.12.2 on page 18 .) | 1 2 |
| multi-10506 ✓ | The value of a <code>multi:identifyingParent</code> attribute on <code>SpeciesTypeComponentIndex</code> objects must conform to the syntax of the SBML data type <code>SIIdRef</code> . (References: Section 3.12.3 on page 19 .) | 3 4 5 |
| multi-10507 ✓ | The value of a <code>multi:speciesTypeComponentIndex</code> attribute on <code>DenotedSpeciesTypeComponentIndex</code> objects must conform to the syntax of the SBML data type <code>SIIdRef</code> . (References: Section 3.13.1 on page 21 .) | 6 7 8 |

| | | |
|----------------------|--|----------------|
| multi-10508 ✓ | The value of a <code>multi:bindingSite1</code> attribute on InSpeciesTypeBond objects must conform to the syntax of the SBML data type <code>SIIdRef</code> . (References: Section 3.14.2 on page 22.) | 9 10 |
| multi-10509 ✓ | The value of a <code>multi:bindingSite2</code> attribute on InSpeciesTypeBond objects must conform to the syntax of the SBML data type <code>SIIdRef</code> . (References: Section 3.14.2 on page 22.) | 11 12 |
| multi-10601 ✓ | The value of a <code>multi:speciesType</code> attribute on Species objects must conform to the syntax of the SBML data type <code>SIIdRef</code> . (References: Section 3.16.1 on page 25.) | 13 14 |
| multi-10602 ✓ | The value of a <code>multi:component</code> attribute on OutwardBindingSite objects must conform to the syntax of the SBML data type <code>SIIdRef</code> . (References: Section 3.17.2 on page 27.) | 15 16 |
| multi-10603 ✓ | The value of a <code>multi:speciesFeatureType</code> attribute on SpeciesFeature objects must conform to the syntax of the SBML data type <code>SIIdRef</code> . (References: Section 3.18.2 on page 29.) | 17 18 |
| multi-10604 ✓ | The value of a <code>multi:component</code> attribute on SpeciesFeature objects must conform to the syntax of the SBML data type <code>SIIdRef</code> . (References: Section 3.18.4 on page 30.) | 19 20 |
| multi-10605 ✓ | The value of a <code>multi:value</code> attribute on SpeciesFeatureValue objects must conform to the syntax of the SBML data type <code>SIIdRef</code> . (References: Section 3.18.6 on page 30.) | 21 22 |
| multi-10701 ✓ | The value of a <code>multi:compartmentReference</code> attribute on SimpleSpeciesReference objects must conform to the syntax of the SBML data type <code>SIIdRef</code> . (References: Section 3.22 on page 36.) | 23 24 25 |
| multi-10702 ✓ | The value of a <code>multi:reactant</code> attribute on SpeciesTypeComponentMapInProduct objects must conform to the syntax of the SBML data type <code>SIIdRef</code> . (References: Section 3.24.1 on page 38.) | 26 27 28 |
| multi-10703 ✓ | The value of a <code>multi:reactantComponent</code> attribute on SpeciesTypeComponentMapInProduct objects must conform to the syntax of the SBML data type <code>SIIdRef</code> . (References: Section 3.24.2 on page 38.) | 29 30 31 |
| multi-10704 ✓ | The value of a <code>multi:productComponent</code> attribute on SpeciesTypeComponentMapInProduct objects must conform to the syntax of the SBML data type <code>SIIdRef</code> . (References: Section 3.24.3 on page 38.) | 32 33 34 |
| multi-10705 ✓ | The value of a <code>multi:reactantSpeciesFeature</code> attribute on SpeciesFeatureChange objects must conform to the syntax of the SBML data type <code>SIIdRef</code> . (References: Section 3.25.2 on page 42.) | 35 36 37 |
| multi-10706 ✓ | The value of a <code>multi:productSpeciesFeature</code> attribute on SpeciesFeatureChange objects must conform to the syntax of the SBML data type <code>SIIdRef</code> . (References: Section 3.25.3 on page 42.) | 38 39 1 |
| multi-10801 ✓ | The value of a <code>multi:compartmentType</code> attribute on Compartment objects must conform to the syntax of the SBML data type <code>SIIdRef</code> . (References: Section 3.5.2 on page 10.) | 2 3 |
| multi-10802 ✓ | The value of a <code>multi:compartment</code> attribute on CompartmentReference objects must conform to the syntax of the SBML data type <code>SIIdRef</code> . (References: Section 3.6.2 on page 11.) | 4 5 |

Rules for extended Model objects

| | | |
|----------------------|---|-------------|
| multi-20101 ✓ | There may be at most one ListOfSpeciesTypes container object within a Model object. (References: Section 3.4 on page 9.) | 6 7 8 |
|----------------------|---|-------------|

- multi-20102** ✓ A **ListOfSpeciesTypes** object within an extended **Model** object is optional, but if present, must not be empty. (References: [Section 3.4 on page 9.](#))
- multi-20103** ✓ A **ListOfSpeciesTypes** object may have the optional SBML core attributes **metaid** and **sboTerm**. No other attributes from the SBML Level 3 Core namespace or the Multi namespace are permitted on a **ListOfSpeciesTypes** object. (References: [Section 3.4.1 on page 9.](#))
- multi-20104** ✓ Apart from the general **notes** and **annotation** subobjects permitted on all SBML objects, a **ListOfSpeciesTypes** container object may only contain **SpeciesType** objects. (References: [Section 3.4.1 on page 9.](#))

Rules for extended **Compartment** objects

- multi-20201** ✓ An extended **Compartment** object must have the required attribute **multi:isType**, and may also have the optional attribute **multi:compartmentType**. No other attributes from the Multi namespace are permitted on an extended **Compartment** object. (References: [Section 3.5 on page 10.](#))
- multi-20202** ✓ The value of a **multi:isType** attribute on an extended **Compartment** object must always confirm to the syntax of the SBML data type **boolean**. (References: [Section 3.5.1 on page 10.](#))
- multi-20203** ✓ The **multi:isType** attribute on an extended **Compartment** object is required. (References: [Section 3.5.1 on page 10.](#))
- multi-20204** ✓ The value of the **multi:isType** attribute of the **Compartment** object referenced by a **CompartmentReference** object must be the same as that of the **multi:isType** attribute of the parent **Compartment** object of the **ListOfCompartmentReferences** object which contains the **CompartmentReference** object. (References: [Section 3.7 on page 11.](#))
- multi-20205** ✓ The **multi:compartmentType** attribute on a **Compartment** object must not be defined if the value of the **multi:isType** is “true”. (References: [Section 3.5.2 on page 10.](#))
- multi-20206** ✓ There may be at most one **ListOfCompartmentReferences** container object within a **Compartment** object. (References: [Section 3.5.3 on page 10.](#))
- multi-20207** ✓ A **ListOfCompartmentReferences** object within a **Compartment** object is optional, but if present, must not be empty. (References: [Section 3.5.3 on page 10.](#))
- multi-20208** ✓ A **ListOfCompartmentReferences** object may have the optional SBML core attributes **metaid** and **sboTerm**. No other attributes from the SBML Level 3 Core namespace or the Multi namespace are permitted on a **ListOfCompartmentReferences** object. (References: [Section 3.5.3 on page 10.](#))
- multi-20209** ✓ Apart from the general **notes** and **annotation** subobjects permitted on all SBML objects, a **ListOfCompartmentReferences** container object may only contain **CompartmentReference** objects. (References: [Section 3.5.3 on page 10.](#))

Rules for **CompartmentReference** objects

- multi-20301** ✓ A **CompartmentReference** object may have the optional SBML Level 3 Core attributes **metaid** and **sboTerm**. No other attributes from the SBML Level 3 Core namespace are permitted on a **CompartmentReference** object. (References: [Section 3.6 on page 11.](#))
- multi-20302** ✓ A **CompartmentReference** object may have the optional SBML Level 3 Core subobjects for **notes** and **annotation**. No other elements from the SBML Level 3 Core namespace are permitted on a **CompartmentReference** object. (References: [Section 3.6 on page 11.](#))

- multi-20303** ✓ A **CompartmentReference** object must have the required attribute `multi:compartment`, and may have the optional attributes `multi:id` and `multi:name`. No other attributes from the Multi namespace are permitted on a **CompartmentReference** object. (References: [Section 3.6 on page 11.](#))
- multi-20304** ✓ The value of the `multi:compartment` attribute must be the value of an `id` attribute on an existing **Compartment** object in the `SId` namespace of the parent **Model**. (References: [Section 3.6 on page 11.](#))
- multi-20305** ✓ If some or all **CompartmentReference** objects within a **ListOfCompartmentReferences** object reference the same **Compartment** object, those `compartmentReferences` are required to have its `multi:id` attribute defined. (References: [Section 3.6.1 on page 11.](#))

Rules for SpeciesType objects

- multi-20401** ✓ A **SpeciesType** object may have the optional SBML Level 3 Core attributes `metaid` and `sboTerm`. No other attributes from the SBML Level 3 Core namespace are permitted on a **SpeciesType** object. (References: [Section 3.8 on page 12.](#))
- multi-20402** ✓ A **SpeciesType** object may have the optional SBML Level 3 Core subobjects for `notes` and `annotation`. No other elements from the SBML Level 3 Core namespace are permitted on a **SpeciesType** object. (References: [Section 3.8 on page 12.](#))
- multi-20403** ✓ A **SpeciesType** object must have the required attribute `multi:id`, and may have the optional attributes `multi:name` and `multi:compartment`. No other attributes from the Multi namespace are permitted on a **SpeciesType** object. (References: [Section 3.8 on page 12.](#))
- multi-20404** ✓ The value of the `multi:compartment` attribute, if set on a given **SpeciesType** object, must be the value of an `id` attribute on an existing **Compartment** object in the `SId` namespace of the parent **Model** object. (References: [Section 3.8.2 on page 12.](#))
- multi-20405** ✓ The various `ListOf__` subobjects within a **SpeciesType** object are optional, but if present, these container objects must not be empty. Specifically, if any of the following classes of objects are present with a **SpeciesType** object, it must not be empty: **ListOfSpeciesFeatureTypes**, **ListOfSpeciesTypeInstances**, **ListOfSpeciesTypeComponentIndexes** and **ListOfInSpeciesTypeBonds**. (References: [Section 3.8 on page 12.](#))
- multi-20406** ✓ There may be at most one **ListOfSpeciesFeatureTypes** container object within a **SpeciesType** object. (References: [Section 3.8 on page 12.](#))
- multi-20407** ✓ Apart from the general `notes` and `annotation` subobjects permitted on all SBML objects, a **ListOfSpeciesFeatureTypes** container object may only contain **SpeciesFeatureType** objects. (References: [Section 3.8.3 on page 13.](#))
- multi-20408** ✓ A **ListOfSpeciesFeatureTypes** object may have the optional SBML core attributes `metaid` and `sboTerm`. No other attributes from the SBML Level 3 Core namespace or the Multi namespace are permitted on a **ListOfSpeciesFeatureTypes** object. (References: [Section 3.8.3 on page 13.](#))
- multi-20409** ✓ There may be at most one **ListOfSpeciesTypeInstances** container object within a **SpeciesType** object. (References: [Section 3.8 on page 12.](#))
- multi-20410** ✓ Apart from the general `notes` and `annotation` subobjects permitted on all SBML objects, a **ListOfSpeciesTypeInstances** container object may only contain **SpeciesTypeInstance** objects. (References: [Section 3.8.4 on page 13.](#))

- multi-20411** ✓ A [ListOfSpeciesTypeInstances](#) object may have the optional SBML core attributes `metaid` and `sboTerm`. No other attributes from the SBML Level 3 Core namespace or the Multi namespace are permitted on a [ListOfSpeciesTypeInstances](#). (References: [Section 3.8.4 on page 13.](#))
- multi-20412** ✓ There may be at most one [ListOfSpeciesTypeComponentIndexes](#) container object within a [SpeciesType](#) object. (References: [Section 3.8 on page 12.](#))
- multi-20413** ✓ Apart from the general `notes` and `annotation` subobjects permitted on all SBML objects, a [ListOfSpeciesTypeComponentIndexes](#) container object may only contain [SpeciesTypeComponentIndex](#) objects. (References: [Section 3.8.6 on page 13.](#))
- multi-20414** ✓ A [ListOfSpeciesTypeComponentIndexes](#) object may have the optional SBML core attributes `metaid` and `sboTerm`. No other attributes from the SBML Level 3 Core namespace or the Multi namespace are permitted on a [ListOfSpeciesTypeComponentIndexes](#) object. (References: [Section 3.8.6 on page 13.](#))
- multi-20415** ✓ There may be at most one [ListOfInSpeciesTypeBonds](#) container object within a [SpeciesType](#) object. (References: [Section 3.8 on page 12.](#))
- multi-20416** ✓ Apart from the general `notes` and `annotation` subobjects permitted on all SBML objects, a [ListOfInSpeciesTypeBonds](#) container object may only contain [InSpeciesTypeBond](#) objects. (References: [Section 3.8.5 on page 13.](#))
- multi-20417** ✓ A [ListOfInSpeciesTypeBonds](#) object may have the optional SBML core attributes `metaid` and `sboTerm`. No other attributes from the SBML Level 3 Core namespace or the Multi namespace are permitted on a [ListOfInSpeciesTypeBonds](#) object. (References: [Section 3.8.5 on page 13.](#))

Rules for BindingSiteSpeciesType objects

- multi-20501** ✓ A [BindingSiteSpeciesType](#) object is not permitted to have any [ListOfSpeciesTypeInstances](#) subobject. (References: [Section 3.8.7 on page 13.](#))

Rules for SpeciesFeatureType objects

- multi-20601** ✓ A [SpeciesFeatureType](#) object may have the optional SBML Level 3 Core attributes `metaid` and `sboTerm`. No other attributes from the SBML Level 3 Core namespace are permitted on a [SpeciesFeatureType](#) object. (References: [Section 3.9 on page 14.](#))
- multi-20602** ✓ A [SpeciesFeatureType](#) object may have the optional SBML Level 3 Core subobjects for `notes` and `annotation`. No other elements from the SBML Level 3 Core namespace are permitted on a [SpeciesFeatureType](#) object. (References: [Section 3.9 on page 14.](#))
- multi-20603** ✓ A [SpeciesFeatureType](#) object must have the required attributes `multi:id` and `multi:occur`, and may have the optional attribute `multi:name`. No other attributes from the Multi namespace are permitted on a [SpeciesFeatureType](#) object. (References: [Section 3.9 on page 14.](#))
- multi-20604** ✓ The value of the `multi:occur` attribute on a given [SpeciesFeatureType](#) object must conform to the syntax of the SBML data type `positiveInteger`. (References: [Section 3.9.2 on page 14.](#))
- multi-20605** ✓ One [ListOfPossibleSpeciesFeatureValues](#) subobject in a [SpeciesFeatureType](#) object is required. (References: [Section 3.9.3 on page 14.](#))
- multi-20606** ✓ A [ListOfPossibleSpeciesFeatureValues](#) object may have the optional SBML core attributes `metaid` and `sboTerm`. No other attributes from the SBML Level 3 Core namespace or the Multi namespace are permitted on a [ListOfPossibleSpeciesFeatureValues](#) object. (References: [Section 3.9.3 on page 14.](#))

- multi-20607** ✓ Apart from the general **notes** and **annotation** subobjects permitted on all SBML objects, a **ListOfPossibleSpeciesFeatureValues** container object may only contain **PossibleSpeciesFeatureValue** objects. (References: [Section 3.9.3 on page 14.](#))
- multi-20608** ✓ A **ListOfPossibleSpeciesFeatureValues** object must not be empty. (References: [Section 3.9.3 on page 14.](#))

Rules for PossibleSpeciesFeatureValue objects

- multi-20701** ✓ A **PossibleSpeciesFeatureValue** object may have the optional SBML Level 3 Core attributes **metaid** and **sboTerm**. No other attributes from the SBML Level 3 Core namespace are permitted on a **PossibleSpeciesFeatureValue** object. (References: [Section 3.10 on page 15.](#))
- multi-20702** ✓ A **PossibleSpeciesFeatureValue** object may have the optional SBML Level 3 Core subobjects for **notes** and **annotation**. No other elements from the SBML Level 3 Core namespace are permitted on a **PossibleSpeciesFeatureValue** object. (References: [Section 3.10 on page 15.](#))
- multi-20703** ✓ A **PossibleSpeciesFeatureValue** object must have the required attribute **multi:id**, and may have the optional attributes **multi:name** and **multi:numericValue**. No other attributes from the Multi namespace are permitted on a **PossibleSpeciesFeatureValue** object. (References: [Section 3.10 on page 15.](#))
- multi-20704** ✓ The value of the **multi:numericValue** attribute on a given **PossibleSpeciesFeatureValue** object must be the identifier of a **Parameter** object defined in the same **Model** object. (References: [Section 3.10.2 on page 15.](#))

Rules for SpeciesTypeInstance objects

- multi-20801** ✓ A **SpeciesTypeInstance** object may have the optional SBML Level 3 Core attributes **metaid** and **sboTerm**. No other attributes from the SBML Level 3 Core namespace are permitted on a **SpeciesTypeInstance** object. (References: [Section 3.11 on page 16.](#))
- multi-20802** ✓ A **SpeciesTypeInstance** object may have the optional SBML Level 3 Core subobjects for **notes** and **annotation**. No other elements from the SBML Level 3 Core namespace are permitted on a **SpeciesTypeInstance** object. (References: [Section 3.11 on page 16.](#))
- multi-20803** ✓ A **SpeciesTypeInstance** object must have the required attributes **multi:id**, **multi:speciesType** and **multi:occur**, and may have the optional attributes **multi:name** and **multi:compartmentReference**. No other attributes from the Multi namespace are permitted on a **SpeciesTypeInstance** object. (References: [Section 3.11 on page 16.](#))
- multi-20804** ✓ The value of the **multi:occur** attribute on a given **SpeciesTypeInstance** object must conform to the syntax of the SBML data type **positiveInteger**. (References: [Section 3.11.4 on page 17.](#))
- multi-20805** ✓ The value of the **multi:speciesType** attribute on a given **SpeciesTypeInstance** object must be the identifier of a **SpeciesType** object defined in the same **Model** object. (References: [Section 3.11.2 on page 16.](#))
- multi-20806** ✓ The value of the **multi:compartmentReference** attribute, if present on a given **SpeciesTypeInstance** object, must be the identifier of a **CompartmentReference** object defined in the same **Model** object. (References: [Section 3.11.3 on page 16.](#))

Rules for SpeciesTypeComponentIndex objects

- multi-20901** ✓ A **SpeciesTypeComponentIndex** object may have the optional SBML Level 3 Core attributes **metaid** and **sboTerm**. No other attributes from the SBML Level 3 Core namespace are permitted on a **SpeciesTypeComponentIndex** object. (References: [Section 3.12 on page 18.](#))

- multi-20902** ✓ A **SpeciesTypeComponentIndex** object may have the optional SBML Level 3 Core subobjects for **notes** and **annotation**. No other elements from the SBML Level 3 Core namespace are permitted on a **SpeciesTypeComponentIndex** object. (References: [Section 3.12 on page 18](#)).
- multi-20903** ✓ A **SpeciesTypeComponentIndex** object must have the required attributes **multi:id**, **multi:compartmentAtt** and **multi:occur**, and may have the optional attribute **multi:identifyingParent**. No other attributes from the Multi namespace are permitted on a **SpeciesTypeComponentIndex** object. (References: [Section 3.12 on page 18](#).)
- multi-20904** ✓ The value of the **multi:component** attribute on a given **SpeciesTypeComponentIndex** object must be the identifier of a **SpeciesTypeInstance** object, or a **SpeciesTypeComponentIndex** object under the **SpeciesType** object that this **SpeciesTypeComponentIndex** object belongs to, or the **SpeciesType** object itself. (References: [Section 3.12.2 on page 18](#).)
- multi-20905** ✓ If the value of the **multi:component** attribute on a given **SpeciesTypeComponentIndex** object is the identifier of a **SpeciesTypeComponentIndex** object, the **SpeciesTypeComponentIndex** object can not have any **ListOfDenotedSpeciesTypeComponentIndexes** object. (References: [Section 3.12.2 on page 18](#).)
- multi-20906** ✓ If the value of the **multi:component** attribute on a given **SpeciesTypeComponentIndex** object is the identifier of another **SpeciesTypeComponentIndex** object, the **multi:occur** attribute must have the same value as that of the **multi:occur** attribute of the referenced **SpeciesTypeComponentIndex** object. (References: [Section 3.12.2 on page 18](#).)
- multi-20907** ✓ The value of the **multi:identifyingParent** attribute on a given **SpeciesTypeComponentIndex** object must be the identifier of a **component** object under the **SpeciesType** object that this **SpeciesTypeComponentIndex** object belongs to. A **component** object can be an object of **SpeciesTypeInstance**, **SpeciesTypeComponentIndex** or **SpeciesType**. (References: [Section 3.12.3 on page 19](#).)
- multi-20908** ✓ The value of the **multi:occur** attribute on a given **SpeciesTypeComponentIndex** object must conform to the syntax of the SBML data type **positiveInteger**. (References: [Section 3.12.4 on page 19](#).)
- multi-20909** ✓ A **ListOfDenotedSpeciesTypeComponentIndexes** object in a **SpeciesTypeComponentIndex** object is optional, but if present, must not be empty. (References: [Section 3.12.5 on page 20](#).)
- multi-20910** ✓ A **ListOfDenotedSpeciesTypeComponentIndexes** object may have the optional SBML core attributes **metaid** and **sboTerm**. No other attributes from the SBML Level 3 Core namespace or the Multi namespace are permitted on a **ListOfDenotedSpeciesTypeComponentIndexes** object. (References: [Section 3.12.5 on page 20](#).)
- multi-20911** ✓ Apart from the general **notes** and **annotation** subobjects permitted on all SBML objects, a **ListOfDenotedSpeciesTypeComponentIndexes** container object may only contain **DenotedSpeciesTypeComponentIndex** objects. (References: [Section 3.12.5 on page 20](#).)

Rules for DenotedSpeciesTypeComponentIndex objects

- multi-21001** ✓ A **DenotedSpeciesTypeComponentIndex** object may have the optional SBML Level 3 Core attributes **metaid** and **sboTerm**. No other attributes from the SBML Level 3 Core namespace are permitted on a **DenotedSpeciesTypeComponentIndex** object. (References: [Section 3.13 on page 21](#)).
- multi-21002** ✓ A **DenotedSpeciesTypeComponentIndex** object may have the optional SBML Level 3 Core subobjects for **notes** and **annotation**. No other elements from the SBML Level 3 Core namespace

are permitted on a [DenotedSpeciesTypeComponentIndex](#) object. (References: [Section 3.13 on page 21](#)).

multi-21003 ✓ A [DenotedSpeciesTypeComponentIndex](#) object must have the required attribute `multi:speciesTypeComponentIndex`. No other attributes from the Multi namespace are permitted on a [DenotedSpeciesTypeComponentIndex](#) object. (References: [Section 3.13.1 on page 21](#).)

multi-21004 ✓ The value of the `multi:speciesTypeComponentIndex` attribute on a given [DenotedSpeciesTypeComponentIndex](#) object must be the identifier of a [SpeciesTypeComponentIndex](#) object defined in the same [Model](#) object. (References: [Section 3.13.1 on page 21](#).)

Rules for InSpeciesTypeBond objects

multi-21101 ✓ An [InSpeciesTypeBond](#) object may have the optional SBML Level 3 Core attributes `metaid` and `sboTerm`. No other attributes from the SBML Level 3 Core namespace are permitted on an [InSpeciesTypeBond](#) object. (References: [Section 3.14 on page 22](#)).

multi-21102 ✓ An [InSpeciesTypeBond](#) object may have the optional SBML Level 3 Core subobjects for `notes` and `annotation`. No other elements from the SBML Level 3 Core namespace are permitted on an [InSpeciesTypeBond](#) object. (References: [Section 3.14 on page 22](#)).

multi-21103 ✓ An [InSpeciesTypeBond](#) object must have the required attributes, `multi:bindingSite1` and `multi:bindingSite2`, and may have the optional attributes, `multi:id` and `multi:name`. No other attributes from the Multi namespace are permitted on an [InSpeciesTypeBond](#) object. (References: [Section 3.14 on page 22](#).)

multi-21104 ✓ The value of the `multi:bindingSite1` attribute on a given [InSpeciesTypeBond](#) object must be the identifier of a [SpeciesTypeInstance](#) object or [SpeciesTypeComponentIndex](#) which ultimately reference a object of [BindingSiteSpeciesType](#). (References: [Section 3.14.2 on page 22](#).)

multi-21105 ✓ The value of the `multi:bindingSite2` attribute on a given [InSpeciesTypeBond](#) object must be the identifier of a [SpeciesTypeInstance](#) object or [SpeciesTypeComponentIndex](#) which ultimately reference a object of [BindingSiteSpeciesType](#). (References: [Section 3.14.2 on page 22](#).)

multi-21106 ✓ The `multi:bindingSite1` and `multi:bindingSite2` attributes must not reference the same [BindingSiteSpeciesType](#) object. (References: [Section 3.14.2 on page 22](#).)

Rules for extended Species objects

multi-21201 ✓ A [Species](#) object may have the optional attribute, `multi:speciesType`. No other attributes from the Multi namespace are permitted on a [Species](#) object. (References: [Section 3.16 on page 25](#).)

multi-21202 ✓ The value of a `multi:speciesType` attribute, if present on a [Species](#) object, must be the identifier of a [SpeciesType](#) object. (References: [Section 3.16.1 on page 25](#).)

multi-21203 ✓ Two `ListOf__` subobjects with a [Species](#) object are optional, but if present, these container object must not be empty. Specifically, if any of the following two classes of objects are present on the [Species](#) object, it must not be empty: [ListOfOutwardBindingSites](#) and [ListOfSpeciesFeatures](#). (References: [Section 3.16 on page 25](#).)

multi-21204 ✓ A [ListOfOutwardBindingSites](#) object may have the optional SBML core attributes `metaid` and `sboTerm`. No other attributes from the SBML Level 3 Core namespace or the Multi namespace are permitted on a [ListOfOutwardBindingSites](#) object. (References: [Section 3.16.2 on page 25](#).)

multi-21205 ✓ Apart from the general `notes` and `annotation` subobjects permitted on all SBML objects, a [ListOfOutwardBindingSites](#) container object may only contain [OutwardBindingSite](#) objects. (References: [Section 3.16.2 on page 25](#).)

- multi-21206** ✓ A **ListOfSpeciesFeatures** object may have the optional SBML Level 3 Core attributes **metaid** and **sboTerm**. No other attributes from the SBML Level 3 Core namespace are permitted on a **ListOfSpeciesFeatures** object. (References: [Section 3.16.3 on page 26.](#))
- multi-21207** ✓ A **ListOfSpeciesFeatures** object may have the optional attribute **multi:relation**. No other attributes from the Multi namespace are permitted on a **ListOfSpeciesFeatures** object. (References: [Section 3.16.3 on page 26.](#))
- multi-21208** ✓ The value of the **multi:relation** attribute, if presented on a **ListOfSpeciesFeatures** object, must conform to the syntax of the Multi data type **Relation**. (References: [Section 3.16.3 on page 26.](#))
- multi-21209** ✓ Apart from the general **notes** and **annotation** subobjects permitted on all SBML objects, a **ListOfSpeciesFeatures** container object may only contain **SpeciesFeature** and/or other **ListOfSpeciesFeatures** objects. (References: [Section 3.16.3 on page 26.](#))

Rules for OutwardBindingSite objects

- multi-21301** ✓ An **OutwardBindingSite** object may have the optional SBML Level 3 Core attributes **metaid** and **sboTerm**. No other attributes from the SBML Level 3 Core namespace are permitted on an **OutwardBindingSite** object. (References: [Section 3.17 on page 27.](#))
- multi-21302** ✓ An **OutwardBindingSite** object may have the optional SBML Level 3 Core subobjects for **notes** and **annotation**. No other elements from the SBML Level 3 Core namespace are permitted on an **OutwardBindingSite** object. (References: [Section 3.17 on page 27.](#))
- multi-21303** ✓ An **OutwardBindingSite** object must have the required attributes, **multi:bindingStatus** and **multi:component**. No other attributes from the Multi namespace are permitted on an **OutwardBindingSite** object. (References: [Section 3.17 on page 27.](#))
- multi-21304** ✓ The value of the **multi:bindingStatus** attribute on a given **OutwardBindingSite** object must confirm to the syntax of the Multi data type **BindingStatus**. (References: [Section 3.17.1 on page 27.](#))
- multi-21305** ✓ The value of the **multi:component** attribute on a given **OutwardBindingSite** object must be the identifier of an object of **SpeciesTypeInstance**, **SpeciesTypeComponentIndex** or **SpeciesType** which ultimately reference an object of **BindingSiteSpeciesType**. (References: [Section 3.17.2 on page 27.](#))

Rules for SpeciesFeature objects

- multi-21401** ✓ A **SpeciesFeature** object may have the optional SBML Level 3 Core attributes **metaid** and **sboTerm**. No other attributes from the SBML Level 3 Core namespace are permitted on a **SpeciesFeature** object. (References: [Section 3.18 on page 29.](#))
- multi-21402** ✓ A **SpeciesFeature** object may have the optional SBML Level 3 Core subobjects for **notes** and **annotation**. No other elements from the SBML Level 3 Core namespace are permitted on a **SpeciesFeature** object. (References: [Section 3.18 on page 29.](#))
- multi-21403** ✓ A **SpeciesFeature** object must have the required attributes, **multi:speciesFeatureType** and **multi:occur**, and may have the optional attributes, **multi:id** and **multi:component**. No other attributes from the Multi namespace are permitted on a **SpeciesFeature** object. (References: [Section 3.18 on page 29.](#))
- multi-21404** ✓ The value of the **multi:speciesFeatureType** attribute on a given **SpeciesFeature** object must be the identifier of a **SpeciesFeatureType** object which is in the **SpeciesType** object

referenced by the **Species** object containing this **SpeciesFeature** object. (References: [Section 3.18.2 on page 29](#).)

- multi-21405 ✓ The value of the **multi:occur** attribute on a given **SpeciesFeature** object must conform to the syntax of the SBML data type **positiveInteger**. The value of the **multi:occur** attribute must not be larger than that of the **multi:occur** attribute of the **SpeciesFeatureType** object referenced by this **SpeciesFeature** object. (References: [Section 3.18.3 on page 29](#).)
- multi-21406 ✓ The value of the **multi:component** attribute on a given **SpeciesFeature** object must be the identifier of an object of **SpeciesTypeInstance**, **SpeciesTypeComponentIndex** or **SpeciesType** which contains this **SpeciesFeature** object. (References: [Section 3.18.4 on page 30](#).)
- multi-21407 ✓ One and only one **ListOfSpeciesFeatureValues** subobject within a **SpeciesFeature** object is required. (References: [Section 3.18.5 on page 30](#).)
- multi-21408 ✓ A **ListOfSpeciesFeatureValues** object must not be empty. (References: [Section 3.18.5 on page 30](#).)
- multi-21409 ✓ A **ListOfSpeciesFeatureValues** object may have the optional SBML core attributes **metaid** and **sboTerm**. No other attributes from the SBML Level 3 Core namespace or the Multi namespace are permitted on a **ListOfSpeciesFeatureValues** object. (References: [Section 3.18.5 on page 30](#).)
- multi-21410 ✓ Apart from the general **notes** and **annotation** subobjects permitted on all SBML objects, a **ListOfSpeciesFeatureValues** container object may only contain **SpeciesFeatureValue** objects. (References: [Section 3.18.5 on page 30](#).)

Rules for SpeciesFeatureValue objects

- multi-21501 ✓ A **SpeciesFeatureValue** object may have the optional SBML Level 3 Core attributes **metaid** and **sboTerm**. No other attributes from the SBML Level 3 Core namespace are permitted on a **SpeciesFeatureValue** object. (References: [Section 3.18.6 on page 30](#).)
- multi-21502 ✓ A **SpeciesFeatureValue** object may have the optional SBML Level 3 Core subobjects for **notes** and **annotation**. No other elements from the SBML Level 3 Core namespace are permitted on a **SpeciesFeatureValue** object. (References: [Section 3.18.6 on page 30](#).)
- multi-21503 ✓ A **SpeciesFeatureValue** object must have the required attribute **multi:value**. No other attributes from the Multi namespace are permitted on a **SpeciesFeatureValue** object. (References: [Section 3.18.6 on page 30](#).)
- multi-21504 ✓ The value of the **multi:value** attribute on a given **SpeciesFeatureValue** object must be the identifier of a **PossibleSpeciesFeatureValue** object defined in the **SpeciesFeatureType** object referenced by the **SpeciesFeature** object containing this **SpeciesFeatureValue** object. (References: [Section 3.18.6 on page 30](#).)

Rules for IntraSpeciesReaction objects

- multi-21601 ✓ An **IntraSpeciesReaction** object may have the optional SBML Level 3 Core attributes **metaid** and **sboTerm**. No other attributes from the SBML Level 3 Core namespace and the Multi namespace are permitted on an **IntraSpeciesReaction** object. (References: [Section 3.21 on page 35](#).)
- multi-21602 ✓ An **IntraSpeciesReaction** object may have the optional SBML Level 3 Core subobjects for **notes** and **annotation**. No other elements from the SBML Level 3 Core namespace are permitted on an **IntraSpeciesReaction** object. (References: [Section 3.21 on page 35](#).)

Rules for extended SimpleSpeciesReference objects

- multi-21701** ✓ An extended **SimpleSpeciesReference** object may have the optional attribute, **multi:compartmentReference**. No other attributes from the Multi namespace are permitted on a **SimpleSpeciesReference** object. (References: [Section 3.22 on page 36.](#))
- multi-21702** ✓ The value of a **multi:compartmentReference** attribute, if present on a **SimpleSpeciesReference** object, must be the identifier of a **CompartmentReference** object. (References: [Section 3.22 on page 36.](#))

Rules for extended SpeciesReference objects

- multi-21801** ✓ A **ListOfSpeciesTypeComponentMapsInProduct** object within an extended **SpeciesReference** object is optional, but if present, must not be empty. (References: [Section 3.23.1 on page 37.](#))
- multi-21802** ✓ A **ListOfSpeciesTypeComponentMapsInProduct** object may have the optional SBML core attributes **metaid** and **sboTerm**. No other attributes from the SBML Level 3 Core namespace or the Multi namespace are permitted on a **ListOfSpeciesTypeComponentMapsInProduct** object. (References: [Section 3.23.1 on page 37.](#))
- multi-21803** ✓ Apart from the general **notes** and **annotation** subobjects permitted on all SBML objects, a **ListOfSpeciesTypeComponentMapsInProduct** container object may only contain **SpeciesTypeComponentMapInProduct** objects. (References: [Section 3.23.1 on page 37.](#))

Rules for SpeciesTypeComponentMapInProduct objects

- multi-21901** ✓ A **SpeciesTypeComponentMapInProduct** object may have the optional SBML Level 3 Core attributes **metaid** and **sboTerm**. No other attributes from the SBML Level 3 Core namespace are permitted on a **SpeciesTypeComponentMapInProduct** object. (References: [Section 3.24 on page 38.](#))
- multi-21902** ✓ A **SpeciesTypeComponentMapInProduct** object may have the optional SBML Level 3 Core subobjects for **notes** and **annotation**. No other elements from the SBML Level 3 Core namespace are permitted on a **SpeciesTypeComponentMapInProduct** object. (References: [Section 3.24 on page 38.](#))
- multi-21903** ✓ A **SpeciesTypeComponentMapInProduct** object must have the required attributes **multi:reactant**, **multi:reactantComponent**, and **multi:productComponent**. No other attributes from the Multi namespace are permitted on a **SpeciesTypeComponentMapInProduct** object. (References: [Section 3.24 on page 38.](#))
- multi-21904** ✓ The value of the **multi:reactant** attribute on a given **SpeciesTypeComponentMapInProduct** object must be the identifier of a reactant **SpeciesReference** object within a reaction. (References: [Section 3.24.1 on page 38.](#))
- multi-21905** ✓ The value of the **multi:reactantComponent** attribute on a given **SpeciesTypeComponentMapInProduct** object must be the identifier of an object of **SpeciesTypeInstance**, **SpeciesTypeComponentIndex** or **SpeciesType**. (References: [Section 3.24.2 on page 38.](#))
- multi-21906** ✓ The value of the **multi:productComponent** attribute on a given **SpeciesTypeComponentMapInProduct** object must be the identifier of an object of **SpeciesTypeInstance**, **SpeciesTypeComponentIndex** or **SpeciesType**. (References: [Section 3.24.3 on page 38.](#))
- multi-21907** ✓ A **ListOfSpeciesFeatureChanges** object within a **SpeciesTypeComponentMapInProduct** object is optional, but if present, must not be empty. (References: [Section 3.24.4 on page 38.](#))

- multi-21908** ✓ A **ListOfSpeciesFeatureChanges** object may have the optional SBML core attributes **metaid** and **sboTerm**. No other attributes from the SBML Level 3 Core namespace or the Multi namespace are permitted on a **ListOfSpeciesFeatureChanges** object. (References: [Section 3.24.4 on page 38.](#))
- multi-21909** ✓ Apart from the general **notes** and **annotation** subobjects permitted on all SBML objects, a **ListOfSpeciesFeatureChanges** container object may only contain **SpeciesFeatureChange** objects. (References: [Section 3.24.4 on page 38.](#))

Rules for SpeciesFeatureChange objects

- multi-22001** ✓ A **SpeciesFeatureChange** object may have the optional SBML Level 3 Core attributes **metaid** and **sboTerm**. No other attributes from the SBML Level 3 Core namespace are permitted on a **SpeciesFeatureChange** object. (References: [Section 3.25 on page 42.](#))
- multi-22002** ✓ A **SpeciesFeatureChange** object may have the optional SBML Level 3 Core subobjects for **notes** and **annotation**. No other elements from the SBML Level 3 Core namespace are permitted on a **SpeciesFeatureChange** object. (References: [Section 3.25 on page 42.](#))
- multi-22003** ✓ A **SpeciesFeatureChange** object must have the required attributes **multi:reactantSpeciesFeature** and **multi:productSpeciesFeature**. No other attributes from the Multi namespace are permitted on a **SpeciesFeatureChange** object. (References: [Section 3.25 on page 42.](#))
- multi-22004** ✓ The value of the **multi:reactantSpeciesFeature** attribute on a given **SpeciesFeatureChange** object must be the identifier of a **SpeciesFeature** object. (References: [Section 3.25.2 on page 42.](#))
- multi-22005** ✓ The value of the **multi:productSpeciesFeature** attribute on a given **SpeciesFeatureChange** object must be the identifier of a **SpeciesFeature** object. (References: [Section 3.25.3 on page 42.](#))

Rules for extended ci elements in Math objects

- multi-22101** ✓ A **ci** element in a **Math** object may have the optional attributes **multi:speciesReference** and **multi:representationType**. No other attributes from the Multi namespace are permitted on a **ci** element. (References: [Section 3.27 on page 45.](#))
- multi-22102** ✓ The value of the **multi:speciesReference** attribute on a given **ci** element must be the identifier of a **SpeciesReference** object. (References: [Section 3.27.1 on page 45.](#))
- multi-22103** ✓ The value of the **multi:representationType** attribute on a given **ci** element must conform to the syntax of the Multi data type **RepresentationType**. (References: [Section 3.27.2 on page 46.](#))

Acknowledgments

6

This work was supported by the Intramural Research Program of the US National Institute of Allergy and Infectious Diseases of the National Institutes of Health.

7

8

References

- Angermann, B. R., Klauschen, F., Garcia, A. D., Prustel, T., Zhang, F., Germain, R. N., and Meier-Schellersheim, M. (2012). Computational modeling of cellular signaling processes embedded into dynamic spatial contexts. *Nat Methods*, 9(3):283–9.
- Barik, D., Baumann, W. T., Paul, M. R., Novak, B., and Tyson, J. J. (2010). A model of yeast cell-cycle regulation based on multisite phosphorylation. *Molecular Systems Biology*, 6:1–18.
- Danos, V. and Laneve, C. (2004). Formal molecular biology. *Theoretical Computer Science*, 325(1):69–110.
- Faeder, J. R., Blinov, M. L., and Hlavacek, W. S. (2009). Rule-based modeling of biochemical systems with BioNetGen. *Methods Mol Biol.*, 500:113–67.
- Feret, J., Danos, V., Krivine, J., Harmer, R., and Fontana, W. (2009). Internal coarse-graining of molecular systems. *PNAS*, 106:6453–6458.
- Hlavacek, W. S., Faeder, J. R., Blinov, M. L., Posner, R. G., Hucka, M., and Fontana, W. (2006). Rules for Modeling Signal-Transduction Systems. *Sci. STKE*, 344:ref6.
- Hucka, M., Bergmann, F., Hoops, S., Keating, S., Sahle, S., Schaff, J., Smith, L., and Wilkinson, D. (2010). The Systems Biology Markup Language (SBML): Language Specification for Level 3 Version 1 Core. Available via the World Wide Web at <http://sbml.org/Documents/Specifications>.
- Malleshaiah, M. K., Shahrezaei, V., Swain, P. S., and Michnick, S. W. (2010). The scaffold protein Ste5 directly controls a switch-like mating decision in yeast. *Nature*, 465:101–105.
- Meier-Schellersheim, M., Xu, X., Angermann, B., Kunkel, E. J., Jin, T., and Germain, R. N. (2006). Key role of local regulation in chemosensing revealed by a new molecular interaction-based modeling method. *PLoS Comput Biol*, 2(7):e82.
- Mu, F., Williams, R. F., Unkefer, C. J. U. P. J., Faeder, J. R., and Hlavacek, W. S. (2007). Carbon-fate maps for metabolic reactions. *Bioinformatics*, 23:3193–3199.
- Novère, N. L. and Oellrich, A. (2010). Multistate and Multicomponent Species (multi). Available via the World Wide Web at http://sbml.org/Community/Wiki/SBML_Level_3_Proposals/Multistate_and_Multicomponent_Species_Proposal.
- Zhang, F., Angermann, B. R., and Meier-Schellersheim, M. (2012). Draft for Discussion: SBML Proposals for "Revised Multi", "Simple Spatial" and "Multi-Spatial" Extensions. In *COMBINE 2012* (http://co.mbine.org/events/COMBINE_2012/agenda?q=system/files/2012-08-15-combine-zhang-SBML_prop_v2.pdf).
- Zhang, F., Angermann, B. R., and Meier-Schellersheim, M. (2013). The Simmune Modeler visual interface for creating signaling networks based on bi-molecular interactions. *Bioinformatics*, 29 (9):1229–1230.
- Zhang, F. and Meier-Schellersheim, M. (2012). Multistate, Multicomponent and Multicompartment Species Package for SBML Level 3 (Multi), rev 221. Available via the World Wide Web at <http://goo.gl/YGXav4>.
- Zhang, F. and Meier-Schellersheim, M. (2013a). Multistate, Multicomponent and Multicompartment Species Package for SBML Level 3 (Multi), rev 280. Available via the World Wide Web at <http://goo.gl/2375K>.
- Zhang, F. and Meier-Schellersheim, M. (2013b). Multistate, Multicomponent and Multicompartment Species Package for SBML Level 3 (Multi), rev 369. Available via the World Wide Web at <http://goo.gl/OcwGUQ>.
- Zhang, F. and Meier-Schellersheim, M. (2013c). Multistate, Multicomponent and Multicompartment Species Package for SBML Level 3 (SBML-Multi). In *HARMONY 2013* (<http://goo.gl/DIyEy>).

Zhang, F and Meier-Schellersheim, M. (2013d). Multistate, Multicomponent and Multicompartment Species Package for SBML Level 3 (SBML-Multi). In *COMBINE 2013* (http://co.mbine.org/events/COMBINE_2013/agenda?q=system/files/sbml_multi_combine_2013%20presentation_FengkaiZhang.pdf). 4160
4161
4162

Zhang, F and Meier-Schellersheim, M. (2014). SBML Multi Package (Breakout session). In *COMBINE 2014* (http://co.mbine.org/events/COMBINE_2014/agenda?q=system/files/Fengkai_Multi_breakout_v6_0.pdf). 4163
4164